

# Transportation Assessment Street Lights Fullerton

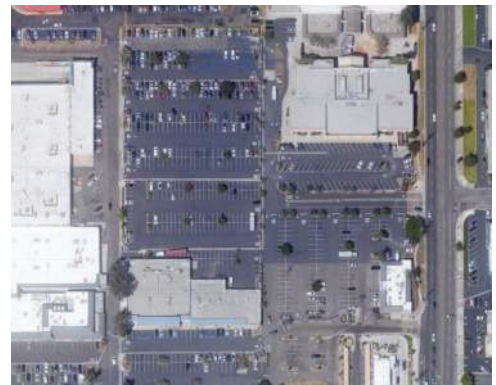

PREPARED FOR



August 2021

Balancing the Natural and Built Environment

PSOMAS

**TRANSPORTATION ASSESSMENT  
STREET LIGHTS FULLERTON  
FULLERTON, CA**

Prepared For



Prepared By

**P S O M A S**

Psomas Project No. 3FUL0201010

August 2021

## TABLE OF CONTENTS

<b>1. INTRODUCTION</b>	<b>1</b>
1.1. STUDY AREA	1
1.2. ANALYSIS METHODOLOGY	5
1.3. ANALYSIS SCENARIOS	6
<b>2. EXISTING STUDY AREA CONDITIONS</b>	<b>7</b>
2.1. ROADWAY NETWORK	7
2.2. TRAFFIC VOLUMES	8
2.3. OPERATIONAL ANALYSIS	8
<b>3. FUTURE TRAFFIC VOLUMES</b>	<b>12</b>
3.1. FUTURE TRAFFIC VOLUMES WITHOUT PROJECT	12
3.2. PROJECT TRAFFIC VOLUMES	17
3.2.1. PROJECT TRIP GENERATION	17
3.2.2. PROJECT TRIP DISTRIBUTION	18
3.2.3. PROJECT TRAFFIC VOLUMES	18
3.3. EXISTING SITE TRAFFIC VOLUMES	21
3.3.1. EXISTING SITE TRIP GENERATION	21
3.3.2. EXISTING SITE TRIP DISTRIBUTION	21
3.4. NET SITE TRAFFIC VOLUMES	22
3.5. FUTURE TRAFFIC VOLUMES WITH PROJECT	22
<b>4. FUTURE OPERATIONS ANALYSIS</b>	<b>26</b>
4.1. TRANSPORTATION IMPROVEMENTS	26
4.2. OPENING YEAR OPERATIONS	26
4.3. GENERAL PLAN YEAR OPERATIONS	30
<b>5. VEHICLE MILES TRAVELED</b>	<b>34</b>
<b>6. CEQA ANALYSES</b>	<b>35</b>

<b>6.1. ACTIVE TRANSPORTATION AND PUBLIC TRANSIT ANALYSIS</b>	<b>35</b>
<b>6.2. SITE ACCESS ANALYSIS</b>	<b>35</b>
<b>6.3. CONSTRUCTION-RELATED TRAFFIC IMPACTS</b>	<b>36</b>
<b>7. CONCLUSION</b>	<b>37</b>
<b>8. REFERENCES</b>	<b>38</b>

APPENDIX A – TRAFFIC VOLUME DATA (2019 AND 2021)

APPENDIX B – HCM/SYNCHRO REPORTS – EXISTING CONDITIONS

APPENDIX C – LEMON STREET IMPROVEMENT PLANS

APPENDIX D – HCM/SYNCHRO REPORTS – OPENING YEAR CONDITIONS

APPENDIX E – HCM/SYNCHRO REPORTS – GENERAL PLAN YEAR CONDITIONS

APPENDIX F – VMT ASSESSMENT



## LIST OF TABLES

TABLE 1. PROJECT TRIP GENERATION _____	17
TABLE 2. EXISTING SITE TRIP GENERATION _____	21
TABLE 3. NET SITE TRIPS _____	22
TABLE 4. OPENING YEAR PEAK HOUR INTERSECTION ANALYSIS _____	30
TABLE 5. GENERAL PLAN YEAR PEAK HOUR INTERSECTION ANALYSIS _____	33

## LIST OF FIGURES

FIGURE 1. PROJECT LOCATION _____	2
FIGURE 2. SITE PLAN _____	3
FIGURE 3. EXISTING INTERSECTION GEOMETRY AND TRAFFIC CONTROL _____	4
FIGURE 4. EXISTING (2021 ADJUSTED) TRAFFIC VOLUMES _____	9
FIGURE 5. EXISTING LEVEL OF SERVICE (LOS) _____	10
FIGURE 6. CUMULATIVE PROJECTS _____	13
FIGURE 7. CUMULATIVE PROJECT TRAFFIC VOLUMES _____	14
FIGURE 8. OPENING YEAR WITHOUT PROJECT TRAFFIC VOLUMES _____	15
FIGURE 9. GENERAL PLAN YEAR WITHOUT PROJECT TRAFFIC VOLUMES _____	16
FIGURE 10. PROJECT TRIP DISTRIBUTION _____	19
FIGURE 11. PROJECT TRAFFIC VOLUMES _____	20
FIGURE 12. NET SITE TRAFFIC VOLUMES _____	23
FIGURE 13. OPENING YEAR WITH PROJECT TRAFFIC VOLUMES _____	24
FIGURE 14. GENERAL PLAN YEAR WITH PROJECT TRAFFIC VOLUMES _____	25
FIGURE 15. OPENING YEAR LEVEL OF SERVICE (LOS) WITHOUT PROJECT _____	28
FIGURE 16. OPENING YEAR LEVEL OF SERVICE (LOS) WITH PROJECT _____	29
FIGURE 17. GENERAL PLAN YEAR LEVEL OF SERVICE (LOS) WITHOUT PROJECT _____	31
FIGURE 18. GENERAL PLAN YEAR LEVEL OF SERVICE (LOS) WITH PROJECT _____	32

## 1. INTRODUCTION

The proposed Street Lights Fullerton Project (Project) is located at 229 East Orangethorpe Avenue within the existing Fullerton Town Center shopping center. The Project consists of the demolition of 9,700 square feet of existing commercial/retail and 6,000 square feet of existing restaurants to construct 329 multi-family units (apartments) above 6,500 square feet of retail shops in a new six-story building. The Project also includes the construction of a 560-space, 6-story parking structure, which will provide parking for both the Project and patrons of the existing shopping center. The Project location is shown in Figure 1. The proposed new site plan for the Project and the shopping center it is located within is included as Figure 2.

### 1.1. STUDY AREA

The five study intersections listed below were identified by the City Traffic Engineer for analysis in this transportation assessment. Three of the study intersections are signalized and two intersections are currently unsignalized. However, the Project includes the signalization of the Liberty Avenue and Lemon Street intersection as both a design feature and a public benefit. Figure 3 shows the existing geometry and traffic controls at each of the five study intersections.

1. Orangethorpe Avenue and Harbor Boulevard (signalized)
2. Orangethorpe Avenue and Pomona Avenue (signalized)
3. Orangethorpe Avenue and Lemon Street (signalized)
4. Liberty Avenue and Lemon Street (unsignalized)
5. Project Driveway and Lemon Street (unsignalized)

**Figure 1. Project Location**

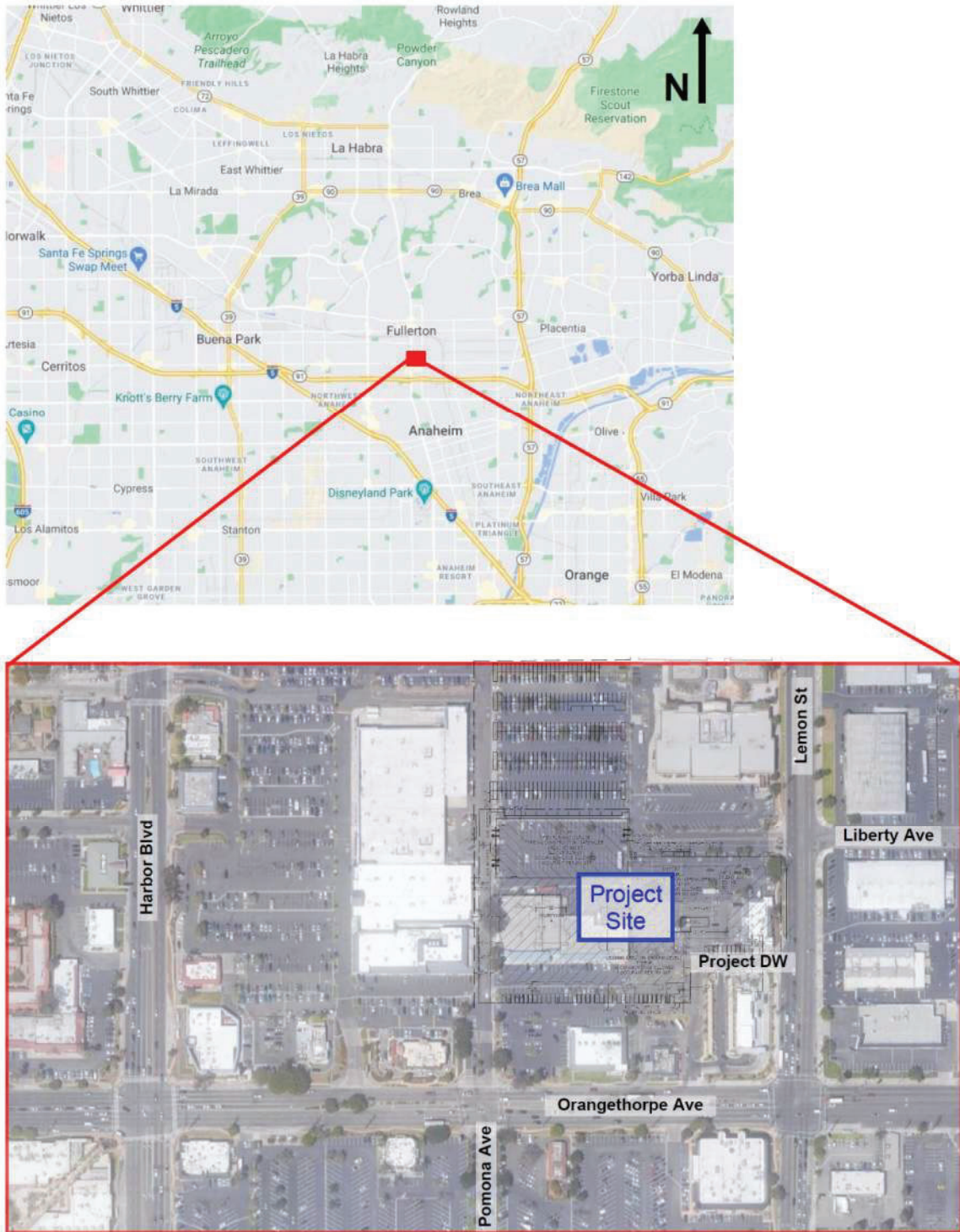

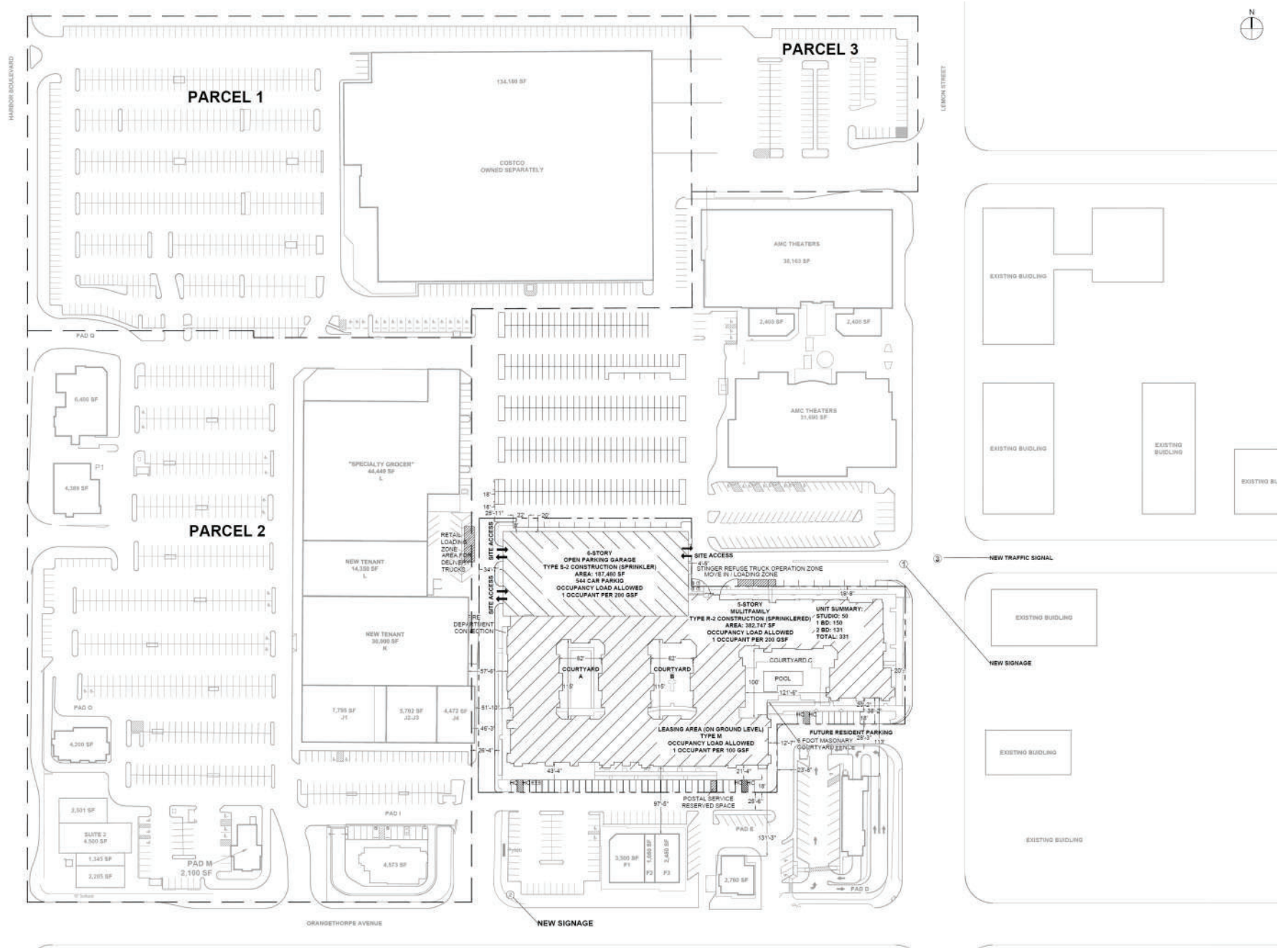



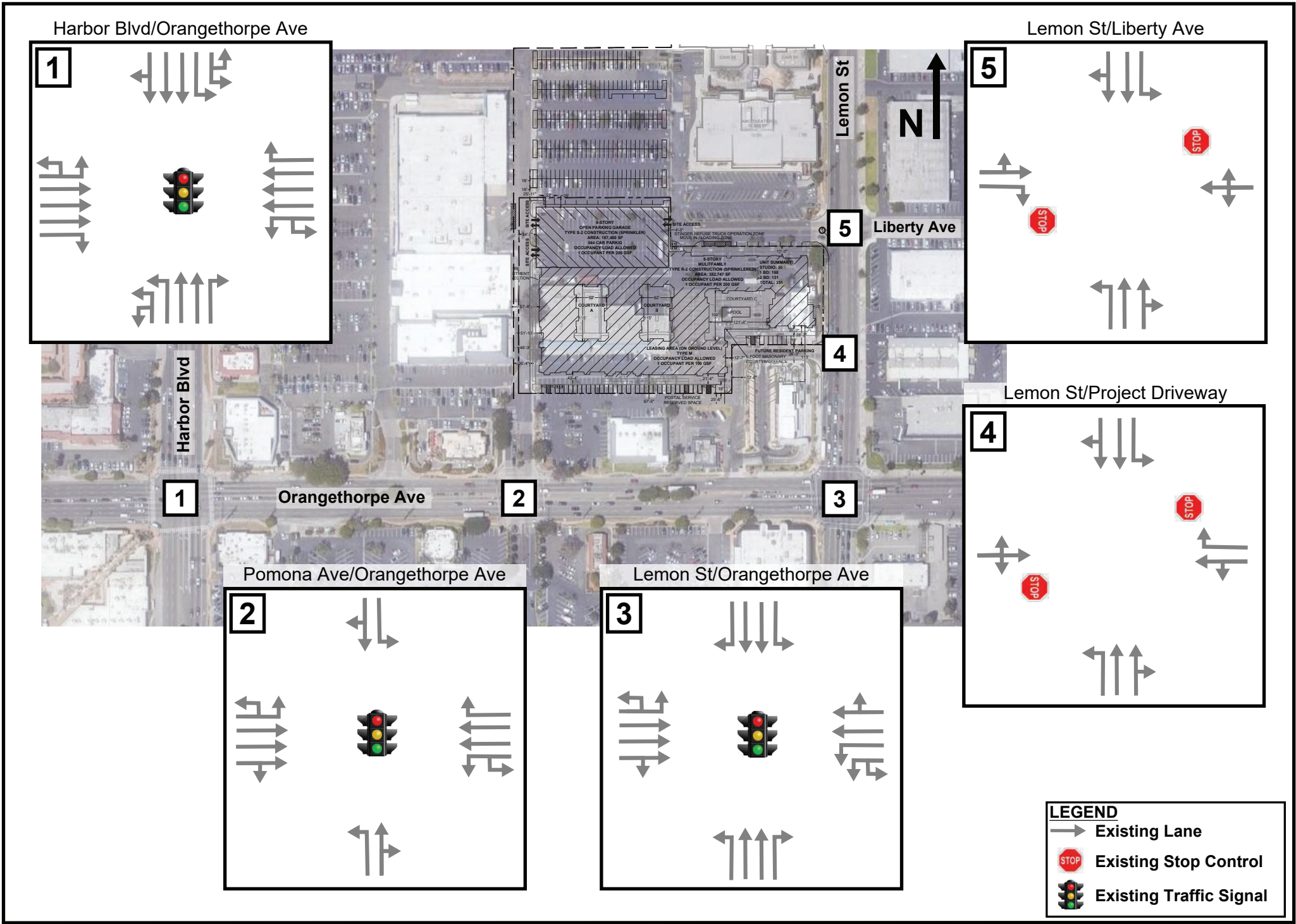

## 1.2. ANALYSIS METHODOLOGY

Level of Service (LOS) is the typical measure used to assess traffic operations at an intersection or along a roadway segment. LOS is commonly expressed in a grading scale ranging from A to F. LOS A represents free traffic flow and excellent operating conditions, whereas LOS F represents forced traffic flow, congestion, and poor operating conditions. Excessive delays and queues typically occur at intersections operating at LOS E or LOS F. Although LOS is no longer used as an analysis methodology for CEQA evaluation purposes, the City of Fullerton continues to require LOS analysis as a part of the development review process to determine if the additional traffic generated by a project is anticipated to degrade traffic operations such that infrastructure improvements will be required as a condition of approval.

This transportation assessment was conducted in accordance with the City of Fullerton's *Transportation Assessment Policies and Procedures*<sup>1</sup>(TAPP). The TAPP calls for the use of the *Highway Capacity Manual (HCM)*<sup>2</sup> traffic assessment methodology to evaluate study intersections. The HCM traffic analyses presented in this report were conducted using the traffic modeling software *Synchro*. The appropriate TAPP study parameters (i.e. lane capacity, minimum split time, etc.) were incorporated into the analysis as applicable. For intersections with at least one U-turn movement, the delays were reported directly from Synchro because the HCM methodology does not provide a specific computation for such movements.

As outlined in the TAPP, acceptable intersection operating conditions are defined as LOS D or better. A development project is anticipated to have a negative effect on the operation of an intersection if any of the following criteria are met:

- The project causes an intersection operating at or above acceptable conditions to degrade to unacceptable conditions.
- The project causes an intersection operating at an unacceptable condition to further degrade. Specifically, for a signalized intersection, the change is:
  - LOS E to LOS F
  - Increase of at least 4 seconds of delay per vehicle for an LOS E intersection
  - Increase of at least 2 seconds of delay per vehicle for an LOS F intersection

If a negative operational effect is identified at an unsignalized intersection, the intersection should be evaluated for the installation of all-way stop control or traffic signal control based on the guidelines and warrants outlined in the latest edition of the *California Manual on Uniform Traffic Control Devices*<sup>3</sup> (CA MUTCD).

Additionally, the Harbor Boulevard and Orangethorpe Avenue intersection is a part of the Orange County Congestion Management Program (CMP). The CMP requires that agencies use the Intersection Capacity Utilization (ICU) analysis methodology to assess whether traffic operations at CMP intersections are degraded by proposed developments that generate 1,600 or more additional trips per day. As discussed in Section 3.4 of this report, implementation of the Project is expected to result in an overall reduction in daily trips; therefore, an ICU analysis is not required by the CMP and is not being provided here within.

### **1.3. ANALYSIS SCENARIOS**

The traffic generated by the Project or by the Project in combination with other projects in the area could worsen the LOS at an intersection. To assess the potential traffic impacts due to the Project and due to background traffic growth and related projects, traffic operations were evaluated for the following scenarios:

- Existing Conditions
- Opening Year (2023) Without Project
- Opening Year (2023) With Project
- General Plan Development Year (2030) Without Project
- General Plan Development Year (2030) With Project

The existing conditions analysis is included in this report to establish a baseline of traffic operations in the study area. It is assumed for the purposes of this assessment that the Project will be completed and available for full occupancy in 2023.



## 2. EXISTING STUDY AREA CONDITIONS

### 2.1. ROADWAY NETWORK

The key roadways within the transportation assessment study area include the following:

**Harbor Boulevard** is a four-lane divided roadway north of Orangethorpe Avenue and a six-lane divided roadway south of Orangethorpe Avenue. From Hill Avenue (just north of Harbor Boulevard) to the south, the roadway is classified as a major arterial highway by *The Fullerton Plan, 2030*<sup>4</sup>. North of Hill Avenue, the Plan classifies the roadway as a primary arterial highway. Within the Project vicinity, Harbor Boulevard has meandering sidewalks with landscaping, bus stops, and a 40 mph posted speed limit; however, on-street parking is not allowed and there are no bike lanes.

**Pomona Avenue** functions as main drive isle and driveway serving both the Fullerton Town Center north of Orangethorpe Avenue and the Orangefair Marketplace south of Orangethorpe Avenue. Pomona Avenue is signalized at Orangethorpe Avenue, providing primary all-way egress and ingress to both shopping centers from Orangethorpe Avenue for vehicles, cyclists, and pedestrians.

**Lemon Street** is a five-lane roadway (two through lanes in each direction and a two-way left turn lane) within the study area. North of Orangethorpe Avenue, the roadway is classified as a primary arterial highway, and south of Orangethorpe Avenue, the roadway is classified as a major arterial highway by *The Fullerton Plan, 2030*. Within the Project vicinity, Lemon Street has meandering sidewalks with landscaping, bus stops, and a 40 mph posted speed limit; however, on-street parking is not allowed and there are no bike lanes.

**Orangethorpe Avenue** is a multi-lane divided roadway in the study area. West of Harbor Boulevard, the roadway includes three through lanes in each direction and a two-way left turn lane. Three through lanes continue east through the remainder of the study area. In the westbound direction, there are three through lanes between Harbor Boulevard and Pomona Avenue and two through lanes between Pomona Avenue to east of Lemon Street. There are no bike lanes or on-street parking in the study area.

Orangethorpe Avenue is classified as a major arterial highway by *The Fullerton Plan, 2030* and the posted speed limit is 40 mph in the study area.

**Liberty Avenue Street** is a two-lane undivided roadway located directly across from an existing driveway for the Fullerton Town Center within the City of Anaheim. The roadway is a loop, providing access to several industrial properties and reconnecting with Lemon Street approximately 560 feet north as Freedom Avenue. Liberty Avenue has a 25 mph prima facie speed limit, no striped lanes, and does not have traditional curb, gutters, and sidewalks.

## **2.2. TRAFFIC VOLUMES**

Traffic volume data was collected at each of the study intersections in March 2021. However, due to the ongoing Covid-19 pandemic, the traffic volumes were adjusted to better approximate what 2021 conditions would be like without the influence of the pandemic. Traffic data was available from 2019 for the intersections of Harbor Boulevard/Orangethorpe Avenue and Lemon Street/Orangethorpe Avenue. A comparison of the 2019 and 2021 data showed that volumes in the AM peak hour in 2021 were between 57% and 63% of 2019 volumes, and 2021 volumes in the PM peak hour were between 82% and 93% of 2019 volumes. The 2021 volumes were adjusted based on the calculated ratios, which varied both by peak hour and location.

The adjusted volumes were reviewed and approved by the City Traffic Engineer before proceeding with the analysis. The “pandemic adjusted” 2021 traffic volumes used in the LOS Assessment are presented in Figure 4. The 2019 traffic data along with the traffic data gathered in March 2021 can be found in Appendix A.

## **2.3. OPERATIONAL ANALYSIS**

In accordance with the City’s TAPP, each of the study intersections were evaluated using the HCM methodology by means of the Synchro traffic modeling software. The LOS values for each study intersection as well as each movement at each of those intersections for both the morning and evening peak hours are presented in Figure 5. The Synchro modeling reports are included for reference in Appendix B

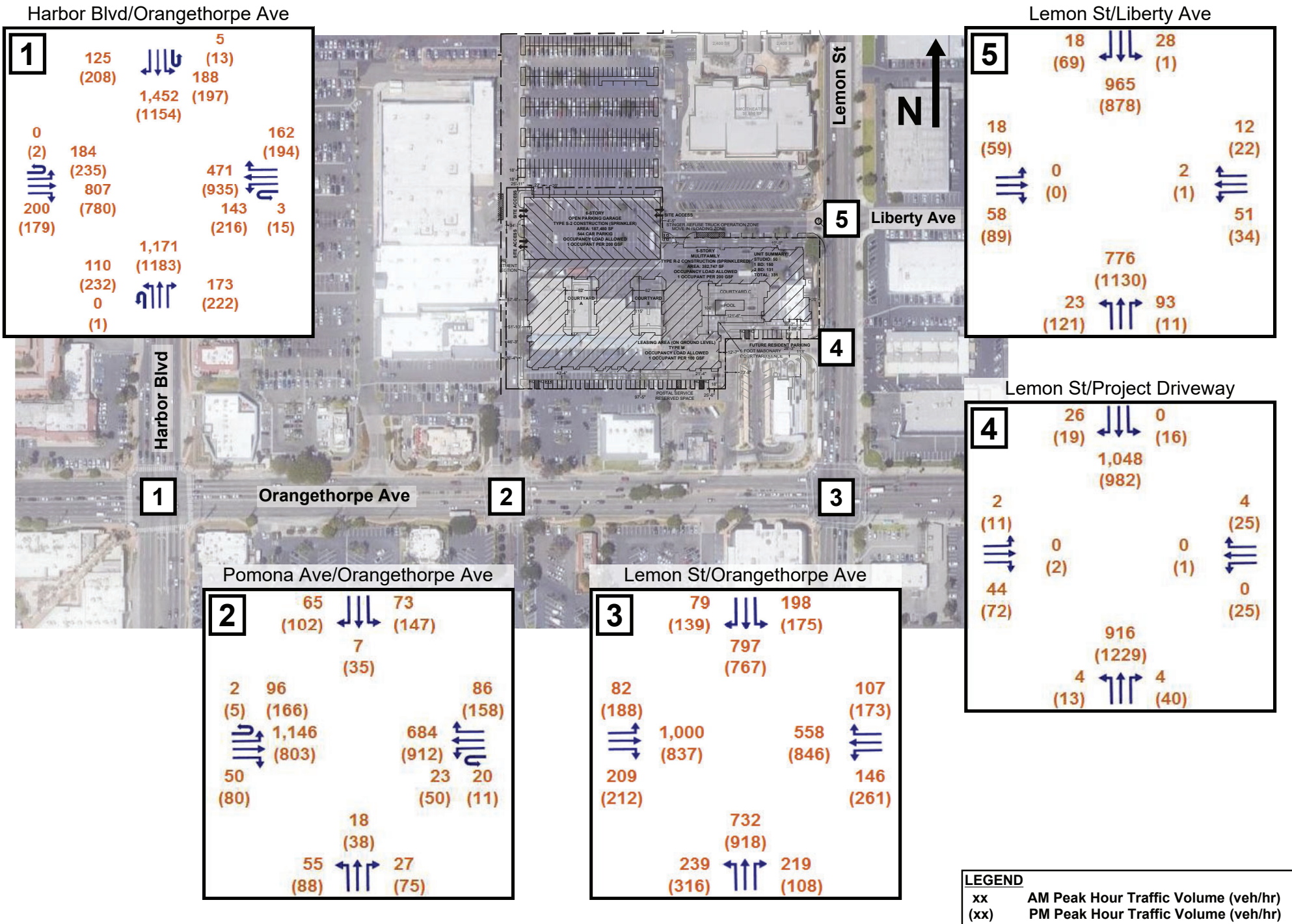

Figure 4.  
Existing (2021 Adjusted) Traffic Volumes



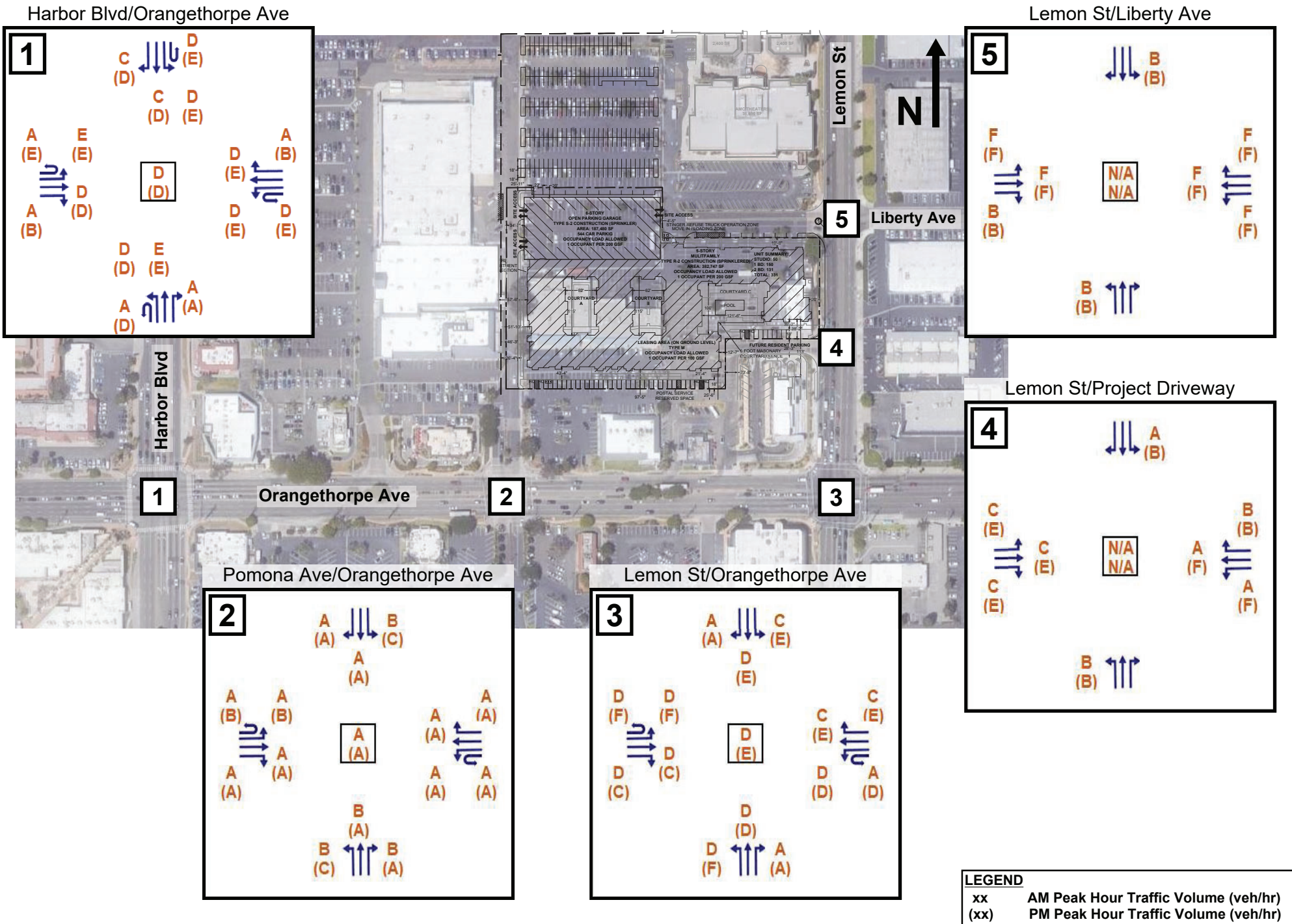

Figure 5.  
Existing Level of Service (LOS)

Note that arterial roadway through traffic movements at the unsignalized driveway intersections are not provided LOS evaluations because those movements are unrestricted by a traffic control device or conflicting traffic. Likewise, the unsignalized intersections do not have an overall intersection LOS because one or more movements are unrestricted.

As shown in Figure 5, the intersection of Orangethorpe Avenue and Lemon Street is currently experiencing unacceptable traffic congestion as signified by its LOS E rating in the PM peak hour. Although some movements at other intersections may not be operating at an LOS D or better rating, the overall traffic operation at those intersections was found to be acceptable as defined in the City's TAPP.

### 3. FUTURE TRAFFIC VOLUMES

#### 3.1. FUTURE TRAFFIC VOLUMES WITHOUT PROJECT

The cumulative traffic volumes are the anticipated traffic volumes in a future year without the project traffic. The anticipated annual ambient growth of traffic for the general plan year is assumed to be 0.5% per year based on population growth estimates in the Southern California Association of Governments (SCAG) Regional Transportation Plan<sup>5</sup> (RTP) and growth projections assumed for traffic volumes in the *City of Fullerton General Plan Update Transportation and Circulation Existing and Build-out Conditions Report*<sup>6</sup>. However, for the purposes of providing a conservative analysis for this study effort, ambient growth of traffic between the existing and opening years was assumed to be 1% per year.

In addition to the ambient growth rate, the estimated traffic volumes generated by nearby development projects were included in the analysis as cumulative projects. The City of Fullerton provided a list of such cumulative projects which are in the entitlement process, under construction, or not yet fully occupied. Two of the projects had recently completed traffic studies which included information regarding trip generation and trip distribution that could be directly incorporated into this study effort. For the remaining three projects, trip generation was estimated using trip generation rates in the Institute of Transportation Engineers (ITE) *Trip Generation Manual*<sup>7</sup> and assumptions were made regarding trip distribution within the study area. The resulting cumulative project traffic volumes were then added to the estimated volumes calculate using the annual growth rate to provide an estimate of opening year and general plan year traffic volumes at the study intersections.

The location of each of the cumulative projects incorporated into this study is presented in Figure 6. The anticipated traffic volumes at each study intersection resulting from the cumulative projects is presented in Figure 7. Figure 8 presents the anticipated traffic volumes at each study intersection for the opening year of 2023 including the anticipated ambient growth in traffic and the cumulative project volumes, but without the anticipated Project traffic. Figure 9 presents the anticipated traffic volumes at each study intersection for the general plan year of 2030 including the anticipated ambient growth in traffic and the cumulative project volumes, but without the anticipated Project traffic.

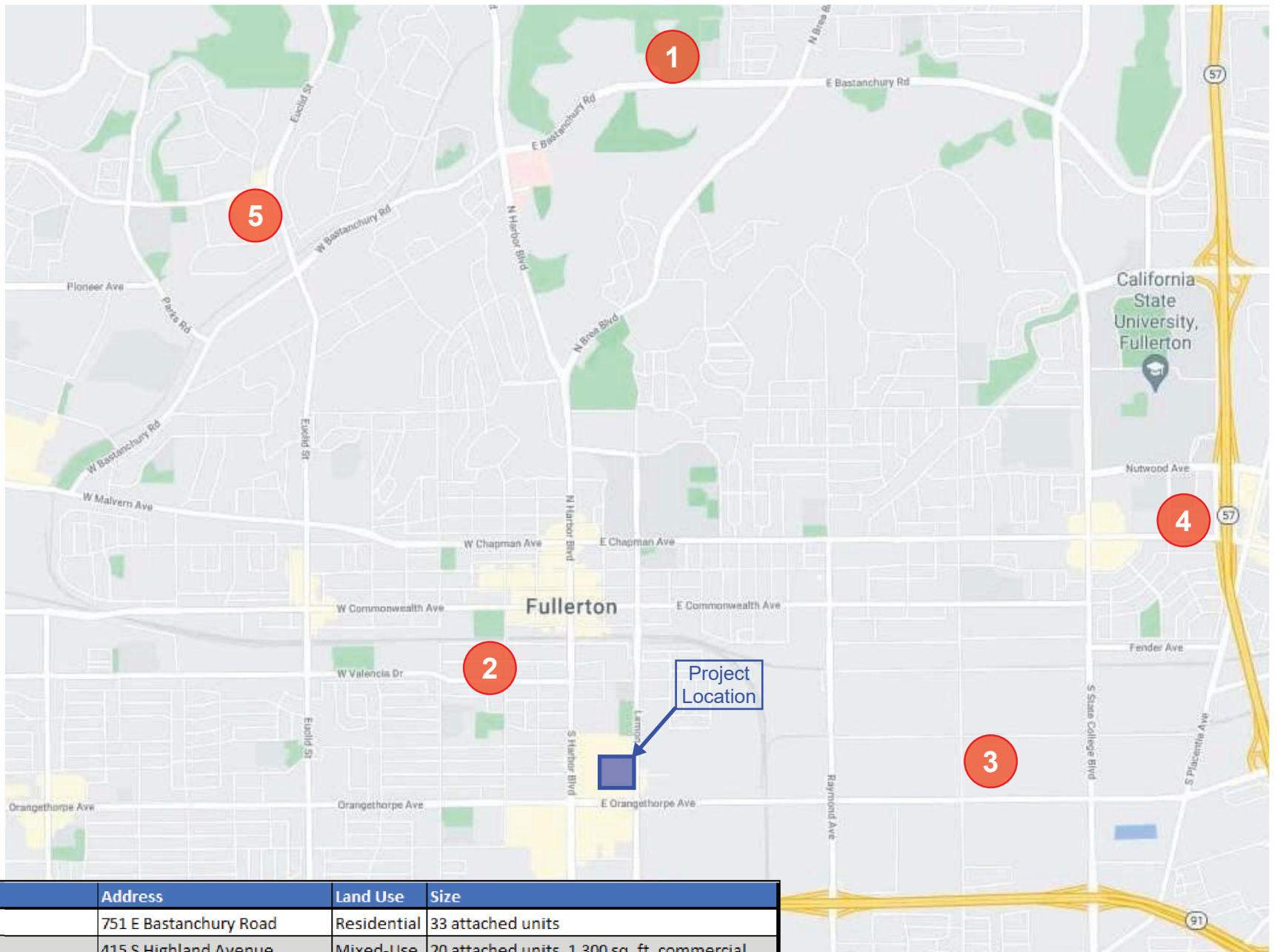

ID #	Project Name	Address	Land Use	Size
1	Brandywine	751 E Bastanchury Road	Residential	33 attached units
2	Casa Bella	415 S Highland Avenue	Mixed-Use	20 attached units, 1,300 sq. ft. commercial
3	Goodman Logistics Center	2001 E Orangethorpe Avenue	Industrial	1,561,522 sq. ft.
4	The Hub	2601 E Chapman Avenue	Mixed-Use	420 attached units, 12,500 sq. ft. commercial
5	The Pines at Sunrise Village	SWC Euclid and Rosecrans	Residential	49 detached units, 115 attached units



Harbor Blvd/Orangethorpe Ave

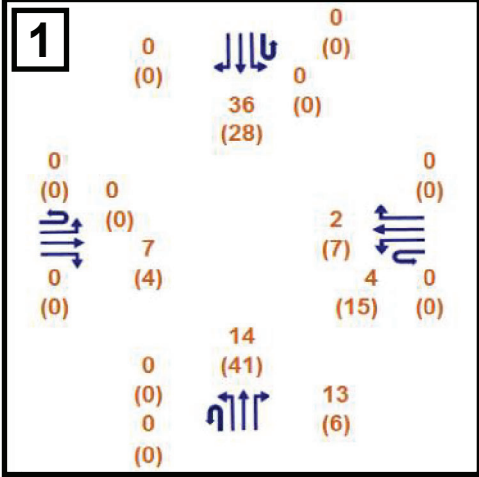

Lemon St/Liberty Ave

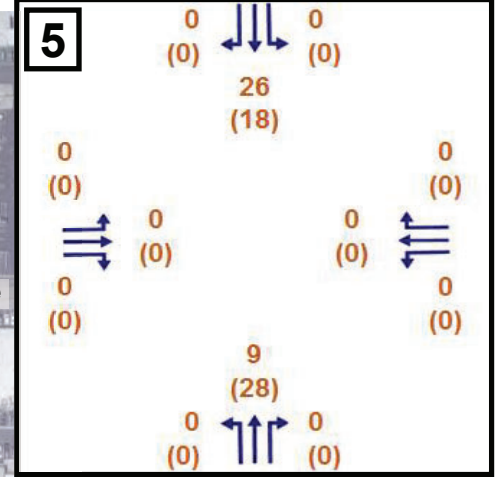

Lemon St/Project Driveway

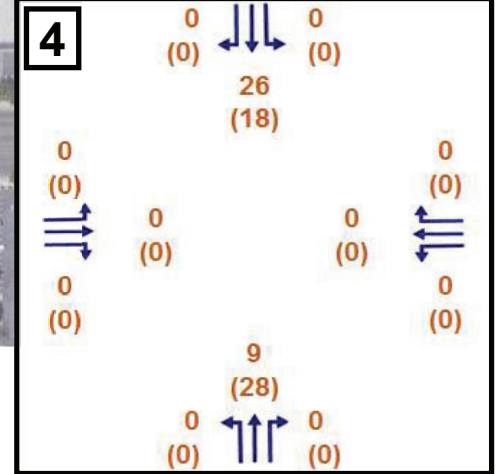

Pomona Ave/Orangethorpe Ave

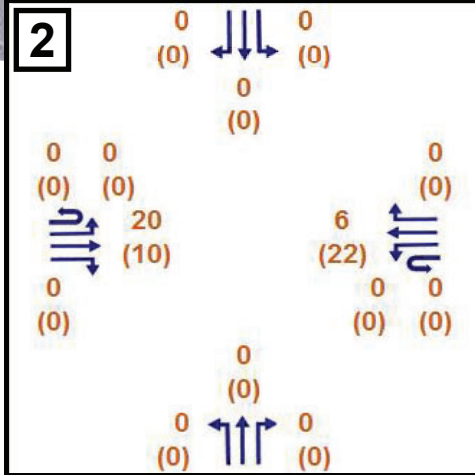

Lemon St/Orangethorpe Ave

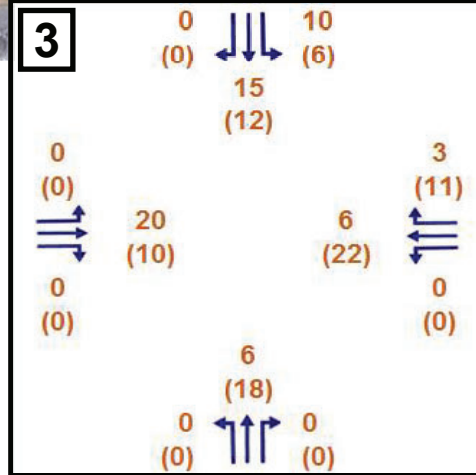

**LEGEND**  
 xx AM Peak Hour Traffic Volume (veh/hr)  
 (xx) PM Peak Hour Traffic Volume (veh/hr)

Figure 7.  
Cumulative Project Traffic Volumes



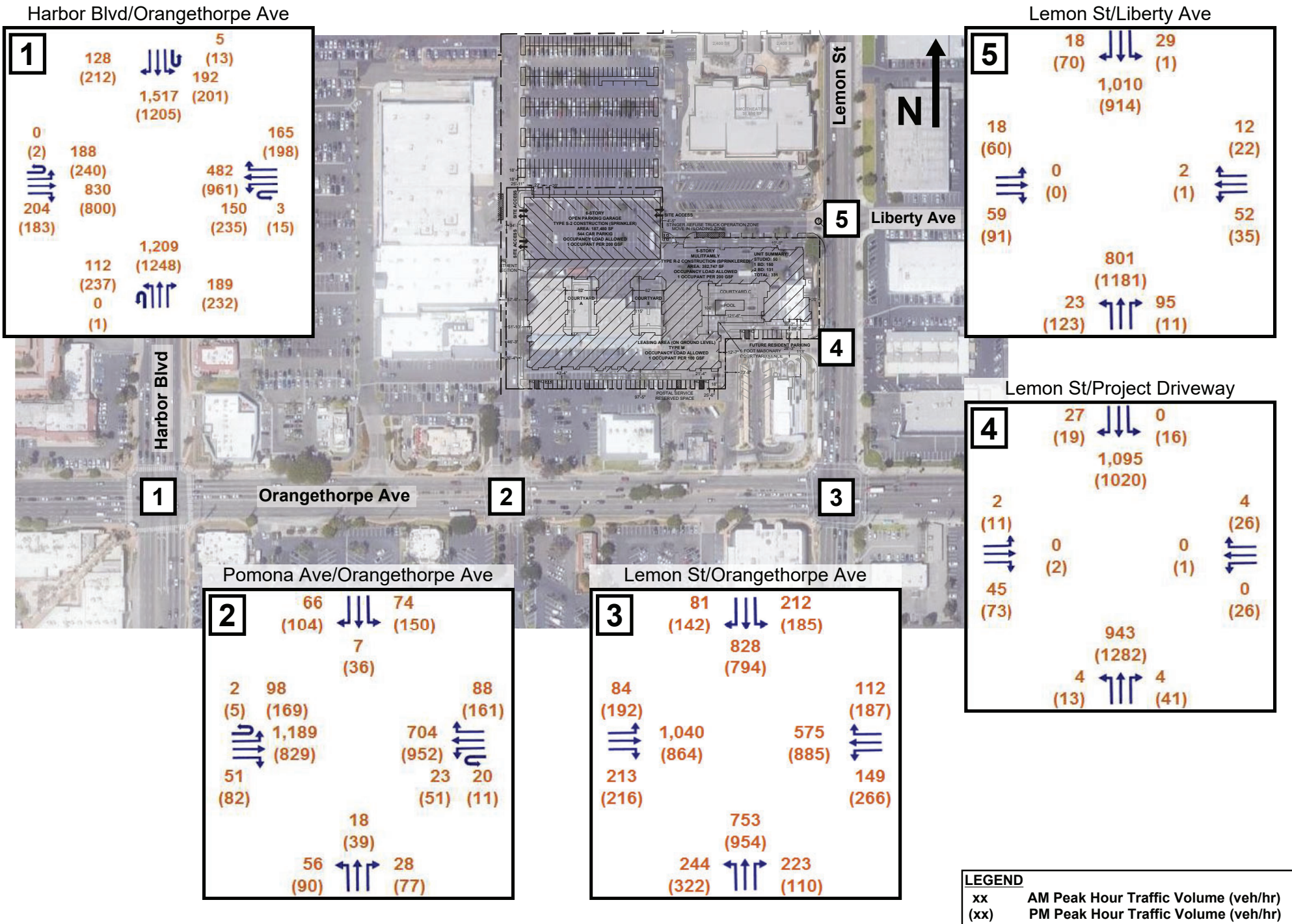

Figure 8.  
Opening Year Without Project Traffic Volumes



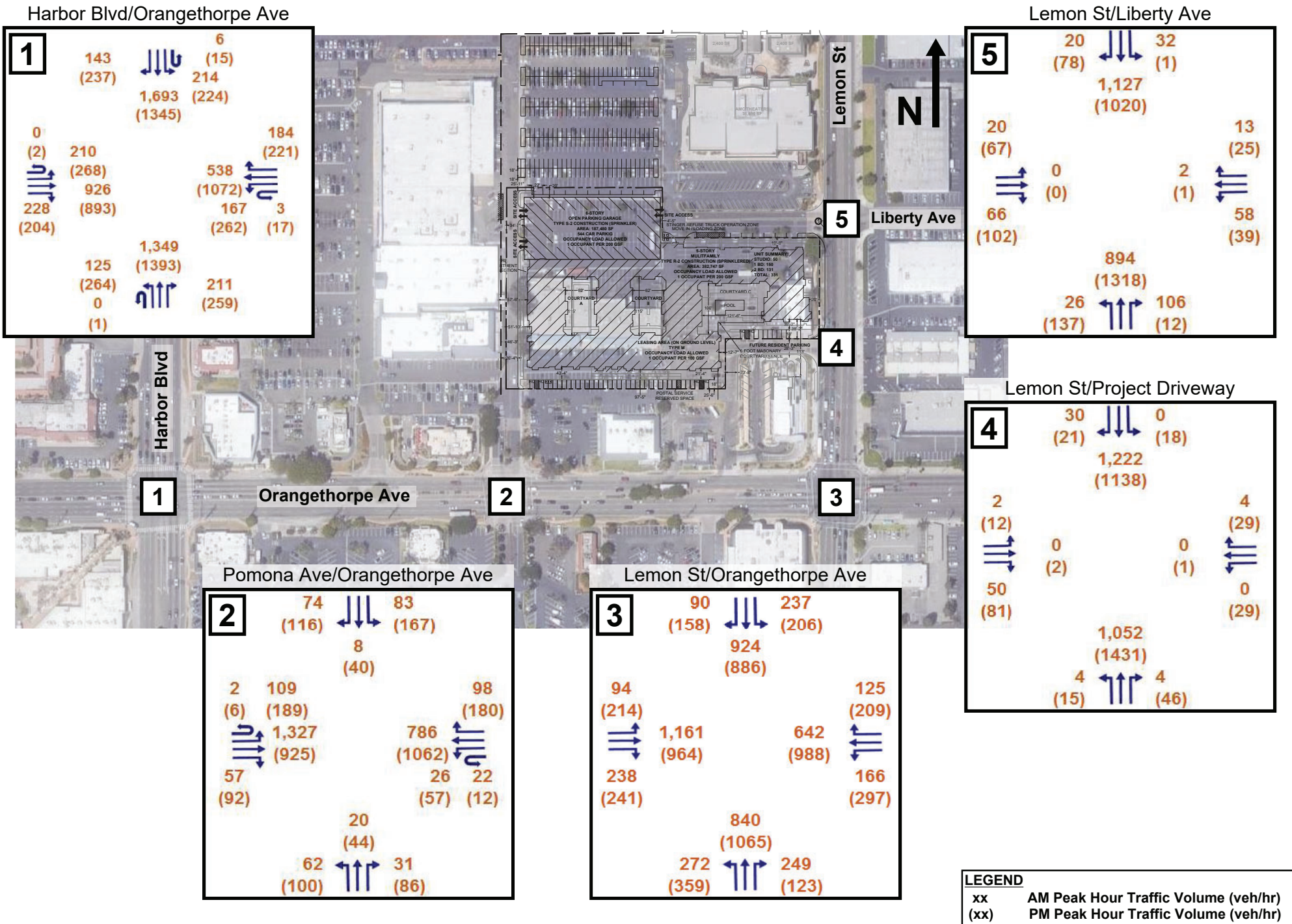

Figure 9.  
General Plan Year Without Project Traffic Volumes

### 3.2. PROJECT TRAFFIC VOLUMES

#### 3.2.1. Project Trip Generation

The proposed Project would construct 329 new attached residential units and 6,500 square feet of new retail space. In order to determine the amount of traffic the new construction will create, trip generation rates from the ITE *Trip Generation Manual, 10<sup>th</sup> Edition* were used to estimate the number of AM peak hour, PM peak hour, and daily trips. To not underestimate the number of trips the new construction would generate, trip reductions were not taken for internal capture or pass-by trips. The resulting Project trip generation is shown in Table 1.

**Table 1. Project Trip Generation**

820 - Shopping Center						
1,000 SF			6.5			
Period	Trips/Unit	Trips	% In	% Out	Trips In	Trips Out
AM Peak	0.94	6	64%	36%	4	2
PM Peak	3.81	25	48%	52%	12	13
Daily	37.75	245	50%	50%	123	123
LU 221 - Multifamily Housing (Mid-Rise)						
Units			329			
Period	Trips/Unit	Trips	% In	% Out	Trips In	Trips Out
AM Peak	0.36	118	26%	74%	31	88
PM Peak	0.44	145	61%	39%	88	56
Daily	5.44	1,790	50%	50%	895	895
TOTAL						
Period	Trips		Trips In		Trips Out	
AM Peak	125		35		90	
PM Peak	170		100		69	
Daily	2,035		1,018		1,018	

### **3.2.2. Project Trip Distribution**

The Project trip distribution was determined based on prevailing traffic patterns, site access, and anticipated origins/destinations of Project residents. The City Traffic Engineer has reviewed the anticipated trip distribution percentages and provided his concurrence. The Project trip distribution percentages used in this study effort are presented in Figure 10.

### **3.2.3. Project Traffic Volumes**

Anticipated Project traffic volumes at each of the study intersections were determined by taking the Project trip generation values for each time period and applying the trip distribution percentages for each movement at every study intersection. The resulting Project traffic volumes are presented in Figure 11.



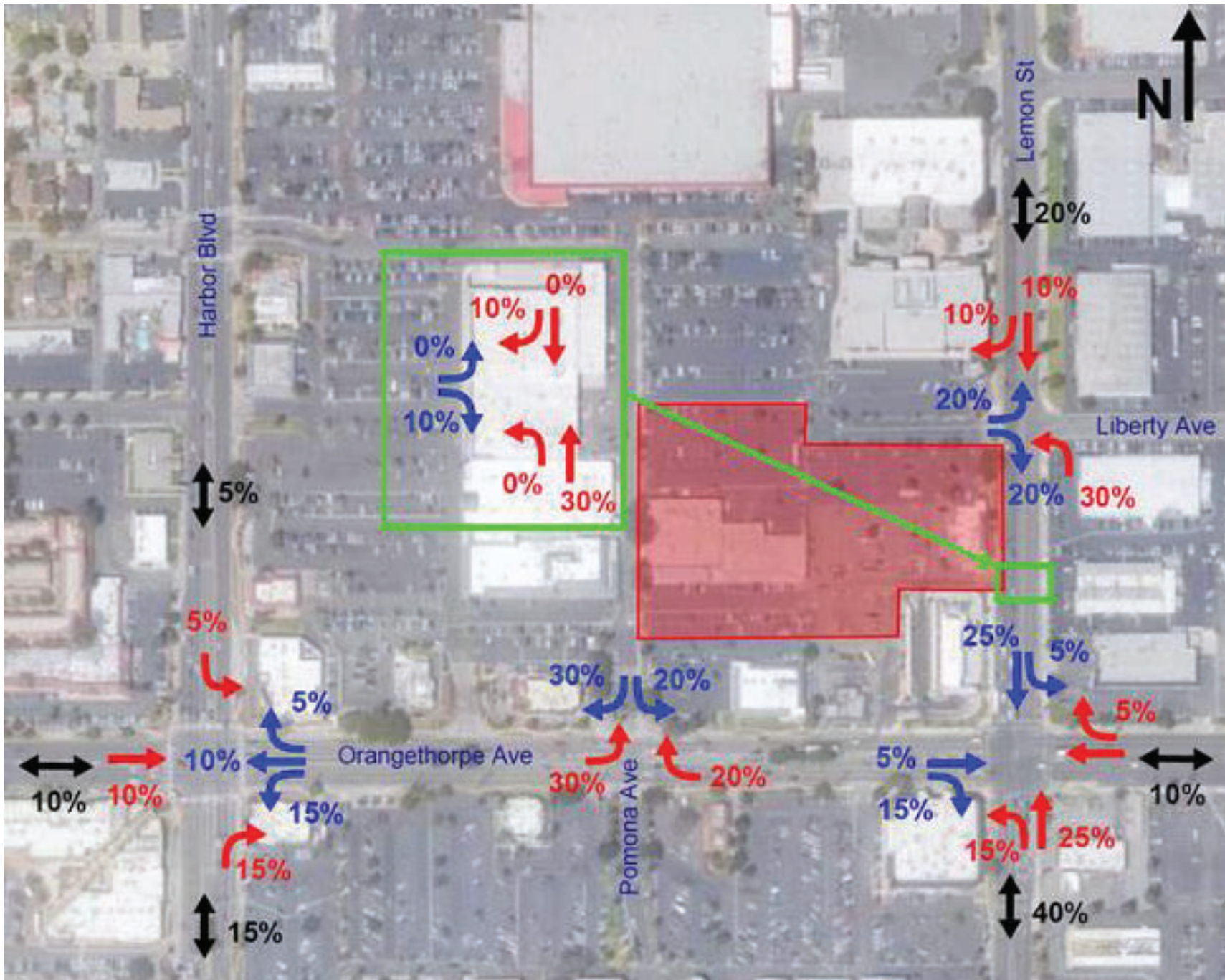



Harbor Blvd/Orangethorpe Ave

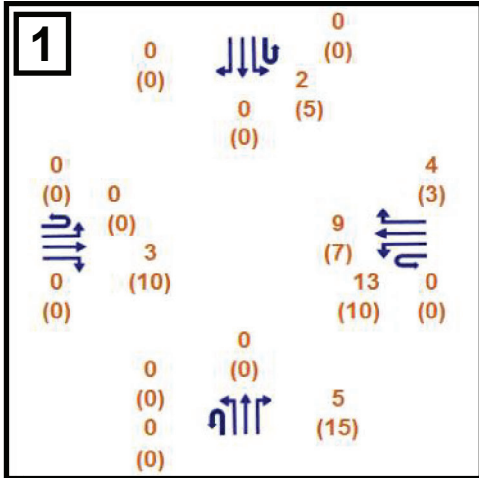

Lemon St/Liberty Ave

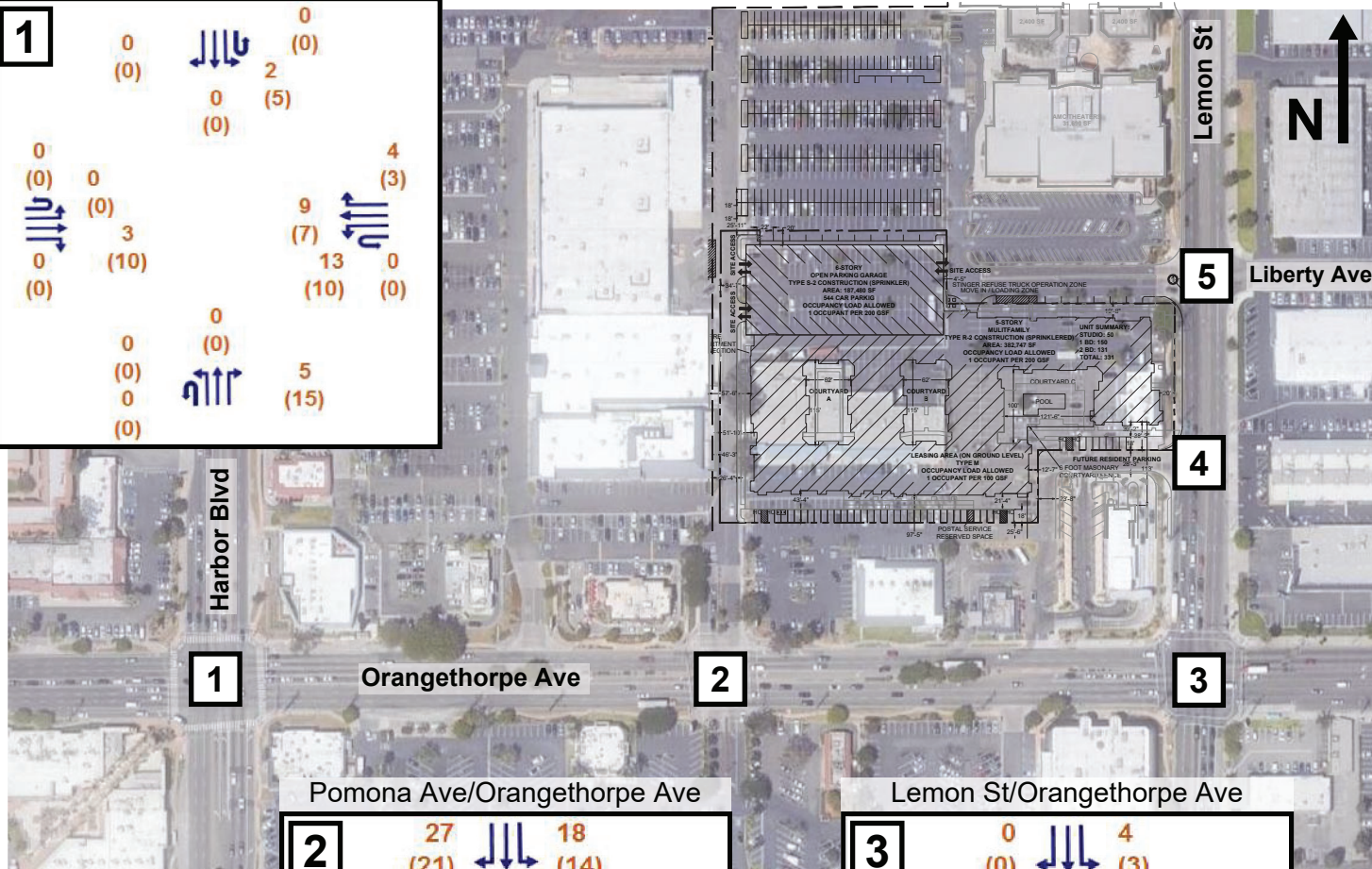
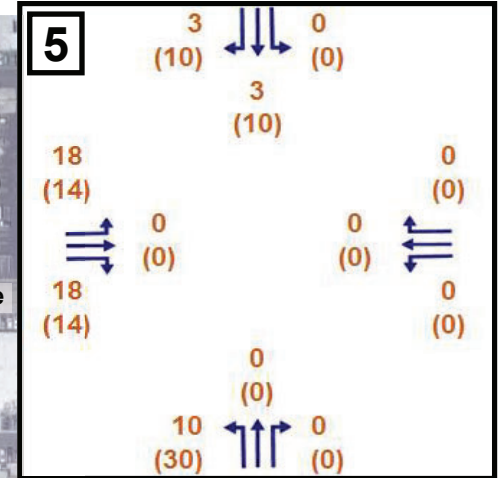

Lemon St/Project Driveway

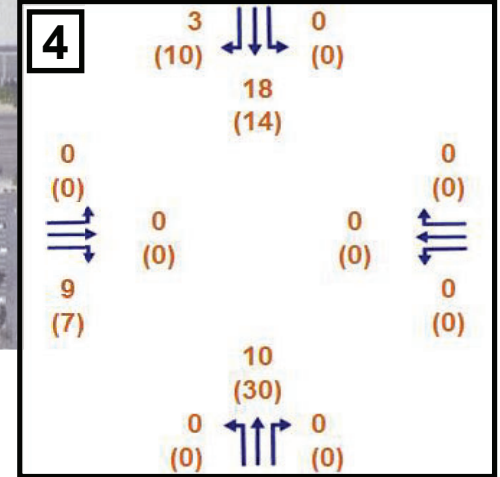

Pomona Ave/Orangethorpe Ave

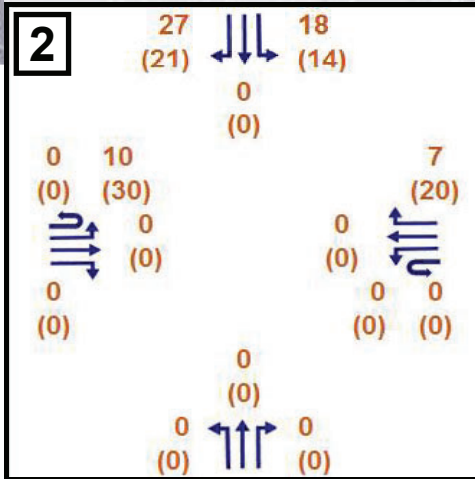

Lemon St/Orangethorpe Ave

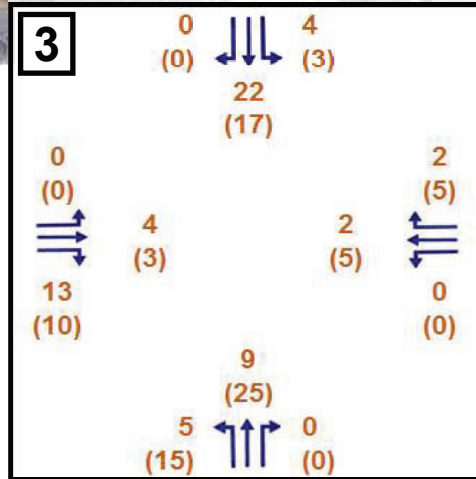

**LEGEND**  
 xx AM Peak Hour Traffic Volume (veh/hr)  
 (xx) PM Peak Hour Traffic Volume (veh/hr)



### 3.3. EXISTING SITE TRAFFIC VOLUMES

#### 3.3.1. Existing Site Trip Generation

Because the Project will be replacing existing retail and commercial buildings with active businesses at the time of the data collection effort, the Project traffic volumes need to be reduced to account for the loss of those businesses. To determine the amount of traffic the existing businesses generate, trip generation rates from the ITE *Trip Generation Manual, 10<sup>th</sup> Edition* were used to determine the number of AM peak hour, PM peak hour, and daily trips that will be eliminated as a part of the Project. Existing business types and sizes were estimated, and the resulting existing site trip generation is shown in Table 2.

**Table 2. Existing Site Trip Generation**

930 - Fast Casual Restaurant						
1,000 SF			6.0			
Period	Trips/Unit	Trips	% In	% Out	Trips In	Trips Out
AM Peak	2.07	12	67%	33%	8	4
PM Peak	14.13	85	55%	45%	47	38
Daily	315.17	1,891	50%	50%	946	946
820 - Shopping Center						
1,000 SF			9.7			
Period	Trips/Unit	Trips	% In	% Out	Trips In	Trips Out
AM Peak	0.94	9	64%	36%	6	3
PM Peak	3.81	37	48%	52%	18	19
Daily	37.75	366	50%	50%	183	183
TOTAL						
Period	Trips		Trips In		Trips Out	
AM Peak	22		14		7	
PM Peak	122		64		57	
Daily	2,257		1,129		1,129	

#### 3.3.2. Existing Site Trip Distribution

Since the existing site access points will not be changing because of the Project, it is assumed that the trip distribution for the existing business is similar to both the Project and the prevailing trip characteristics of the existing shopping center.

### 3.4. NET SITE TRAFFIC VOLUMES

Table 3 presents a summary of the net site trips for the Project, which were calculated by subtracting the existing site trips from the trips anticipated to be generated by the new construction. As outlined in Table 3, the Project is expected to result in an increased number of peak hour trips in both the AM peak and the PM peak; however, the Project will result in a reduction in the total daily trips to and from the site. The largest increase in trips is projected to occur during the AM peak hour when the shopping center and most of the commercial part of the project is closed for business; however, residents will be leaving for work. Specifically, the project is anticipated to generate 103 additional AM peak hour trips when compared to the existing site. During the PM peak hour when the uses to be replaced are fully open for business, the Project is anticipated to generate only 48 trips more than the existing site. Because commercial space, on average, generates more daily trips than residential space, the Project is expected to generate 222 fewer daily trips when compared to the existing site. Figure 12 shows the distributed Project net site trips at each of the study intersections.

**Table 3. Net Site Trips**

Period	Trips	Trips In	Trips Out
AM Peak	103	21	82
PM Peak	48	36	12
Daily	-222	-111	-111

### 3.5. FUTURE TRAFFIC VOLUMES WITH PROJECT

To estimate traffic volumes in a future year, traffic generated by ambient growth of traffic, cumulative projects, and by the Project itself must be considered. Future volumes with the Project were calculated by adding existing traffic volumes, the cumulative growth (including ambient growth of traffic and cumulative projects), and the net site trips distributed over the study intersections. Figure 13 presents the opening year traffic volumes with the Project for each study intersection. Figure 14 presents the general plan year traffic volumes with the Project for each study intersection.

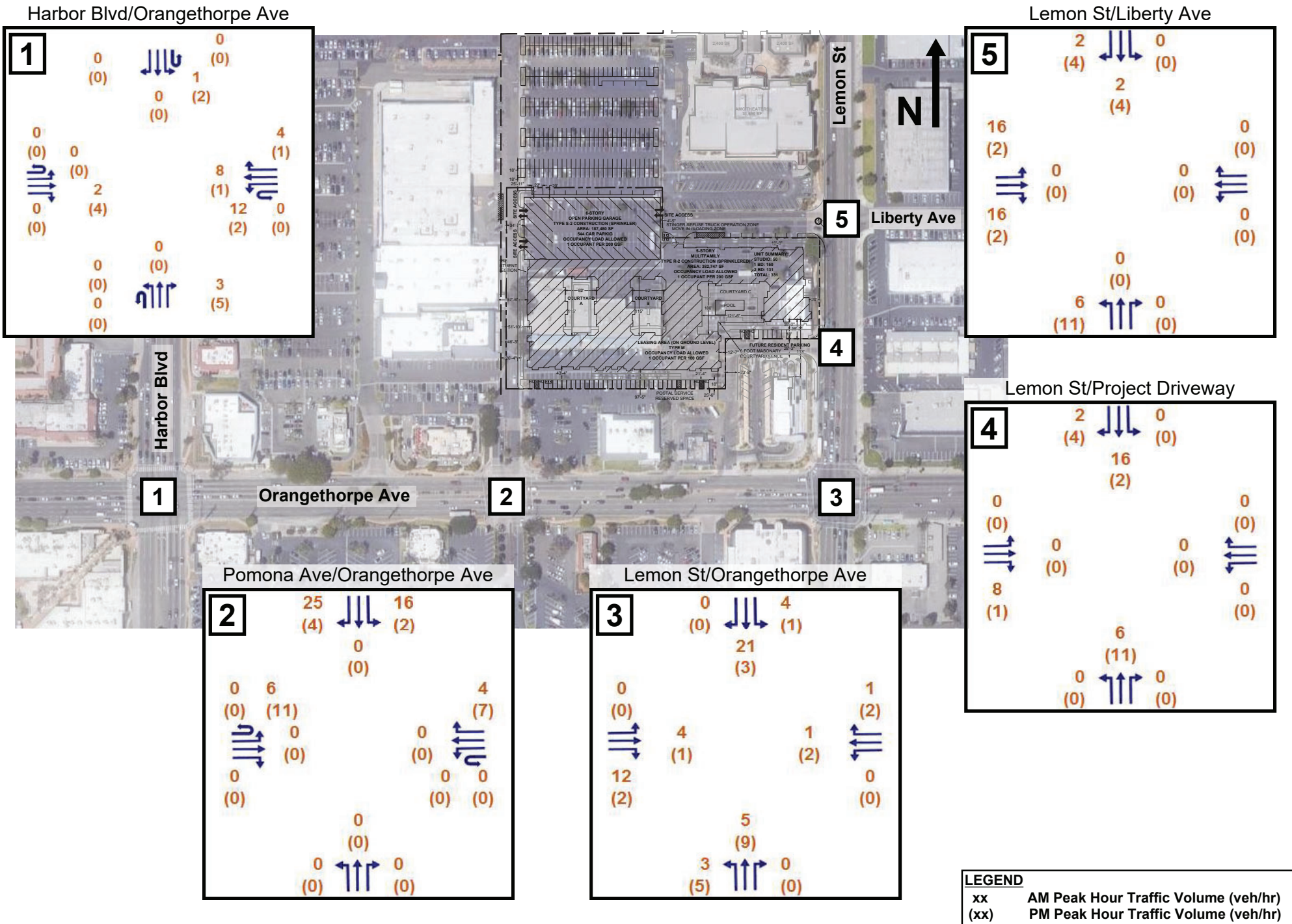

Figure 12.  
 Net Site Traffic Volumes



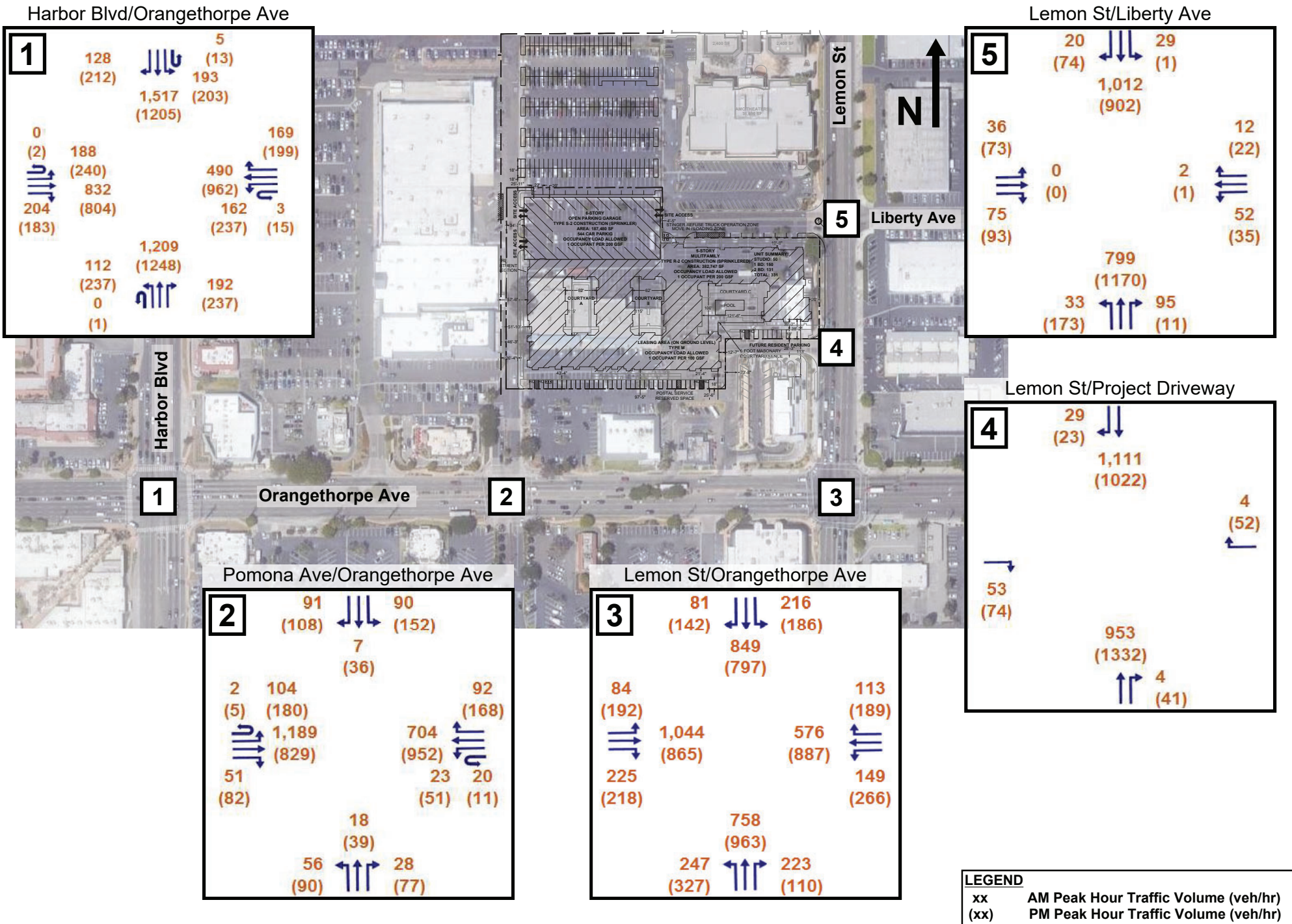
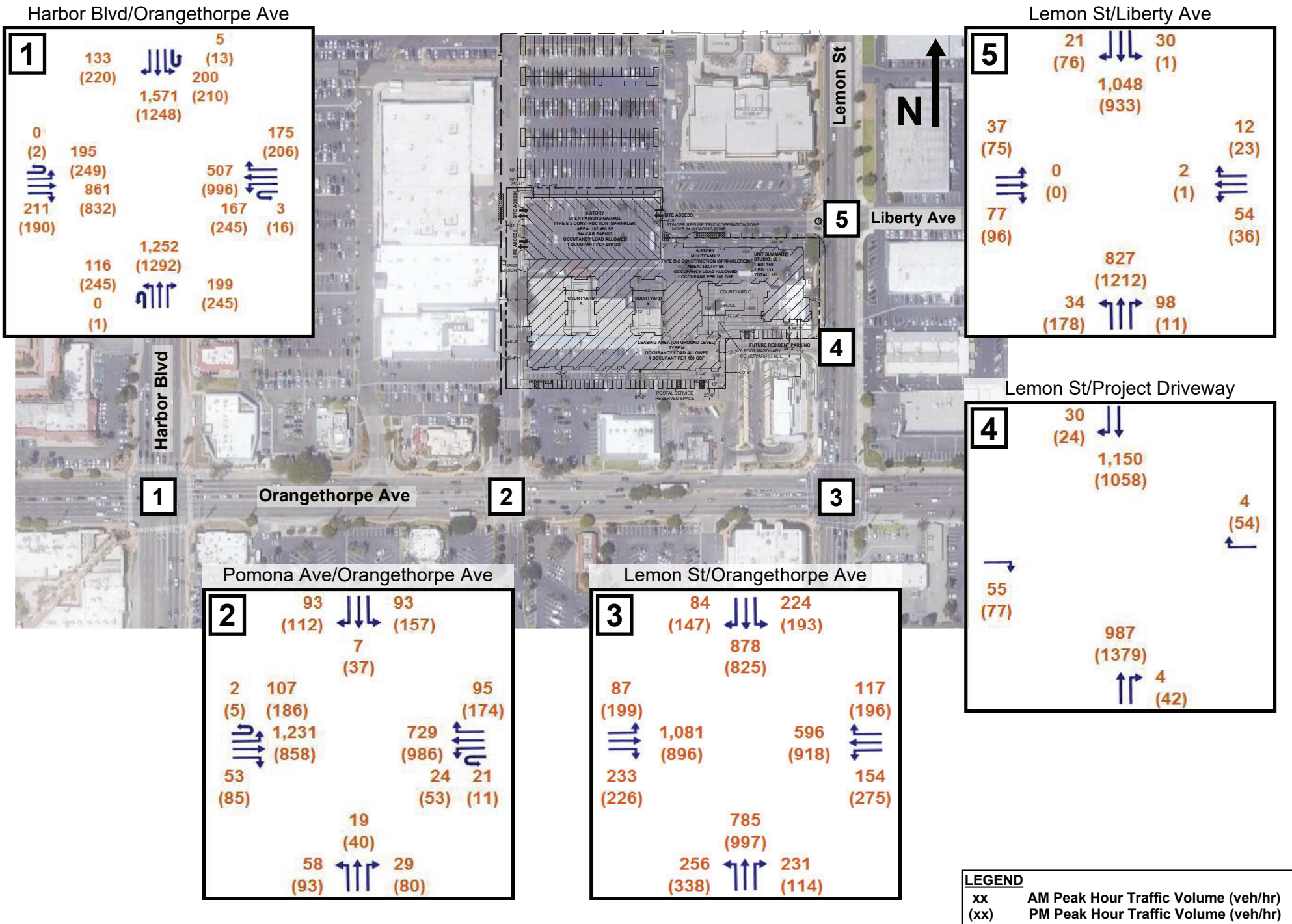

Figure 13.  
Opening Year With Project Traffic Volumes





## **4. FUTURE OPERATIONS ANALYSIS**

### **4.1. TRANSPORTATION IMPROVEMENTS**

Although no publicly funded major roadway improvements are planned in the study area, the Project will include construction of access and traffic flow improvements along Lemon Street north of Orangewood Avenue. A traffic signal will be installed at the intersection of Lemon Street and Liberty Avenue, providing signalized access for the Project as well as the existing shopping center. The traffic signal will be equipped with safety lighting, crosswalks, and pedestrian facilities as well as a northbound left turn arrow for vehicular traffic. The signal was assumed to operate with leading protected-permissive left turns for northbound and southbound traffic, and with split phasing for eastbound and westbound traffic. The signal will be a joint effort by the City of Fullerton and the City of Anaheim.

In addition to the new traffic signal, Lemon Street will be widened, and the striping reconfigured to provide new southbound right turn lanes at the Lemon Street/Liberty Avenue intersection and at the Lemon Street Project driveway located between Liberty Avenue and Orangethorpe Avenue. The restriping of Lemon Avenue will also include new northbound and southbound left turn lanes at the Lemon Street/Liberty Avenue intersection. The proposed traffic improvements are presented in conceptual form in Appendix C.

### **4.2. OPENING YEAR OPERATIONS**

In accordance with the City's TAPP, each of the study intersections were evaluated using the HCM methodology within the Synchro traffic modeling software. The opening year LOS for both the morning and evening peak hours at each study intersection, as well as each movement at each of those intersections, are presented in Figure 15. The LOS analysis results for the opening year with the Project are presented in Figure 16. It is important to note that in Figure 16 the intersection of Lemon Street and Liberty Avenue is provided an intersection level LOS rating since it will be signalized with the Project. The Synchro modeling reports for the opening year are included for reference in Appendix D.

As outlined in Figure 15 and Figure 16, operations at three intersections are expected to operate be unacceptable during the PM peak hour as signified by their LOS E rating. Those three intersections operating below an acceptable LOS in the PM peak hour are Orangethorpe Avenue/Harbor Boulevard, Orangethorpe Avenue/Lemon Street, and Liberty Avenue/Lemon Street. As shown in Figure 16, the intersections of Orangethorpe Avenue/Harbor Boulevard and Orangethorpe Avenue/Lemon Street are expected to continue to operate at LOS E with the Project. However, operations at the Liberty Avenue/Lemon Street intersection will improve to LOS B with the installation of a traffic signal as part of the Project.

Table 4 presents a comparison of opening year study intersection operations both with and without the Project. Although it is anticipated that vehicle delays at the three intersections along Orangethorpe Avenue will worsen slightly with the implementation of the Project, the anticipated increase in delay associated with the Project falls below the level that could be considered as causing a detrimental effect on traffic operations. Therefore, in accordance with the City's TAPP, it is concluded that the Project itself will not excessively worsen traffic operations in the opening year. Therefore, no further traffic improvements are necessary or required beyond those already planned with the Project.



Harbor Blvd/Orangethorpe Ave

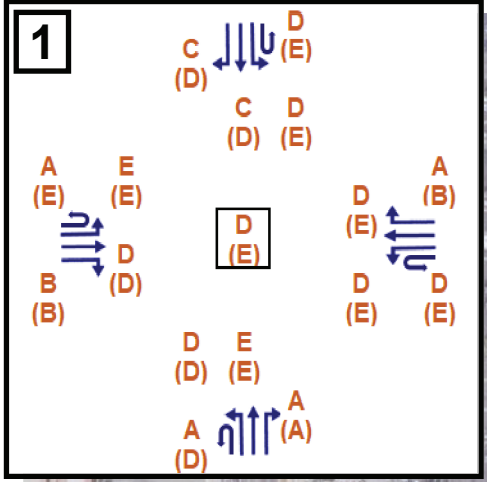

Lemon St/Liberty Ave

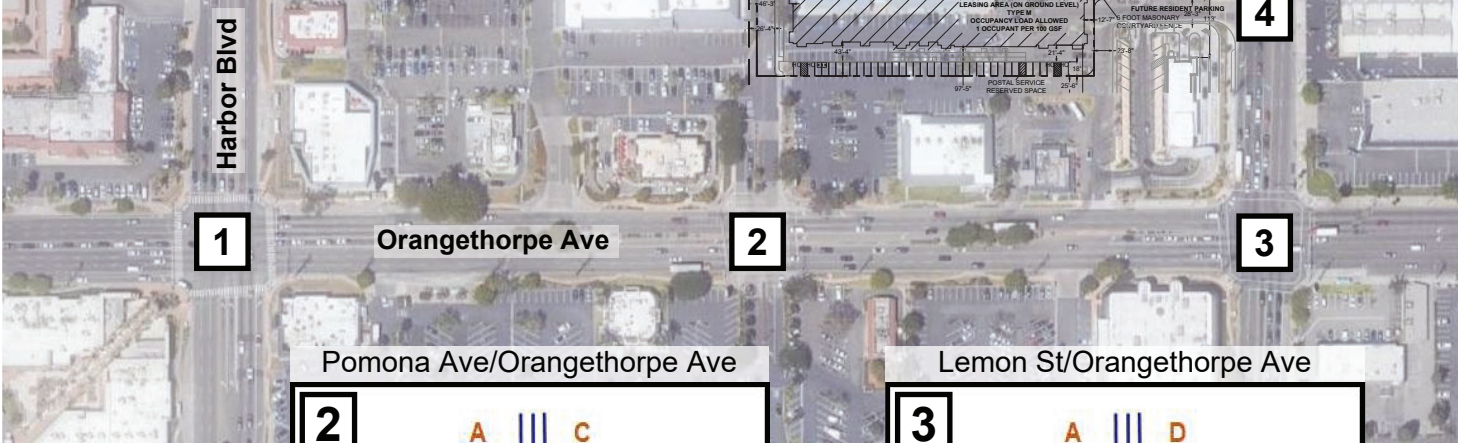
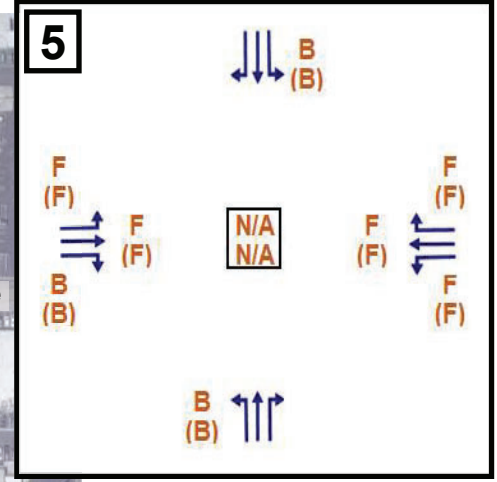

Orangethorpe Ave

Pomona Ave/Orangethorpe Ave

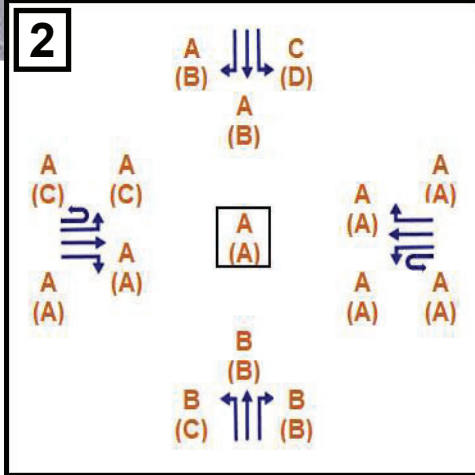

Lemon St/Orangethorpe Ave

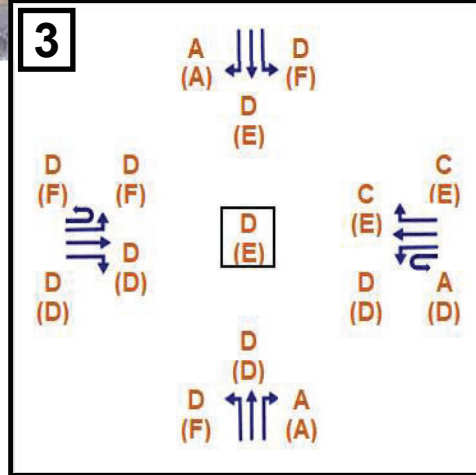

Lemon St/Project Driveway

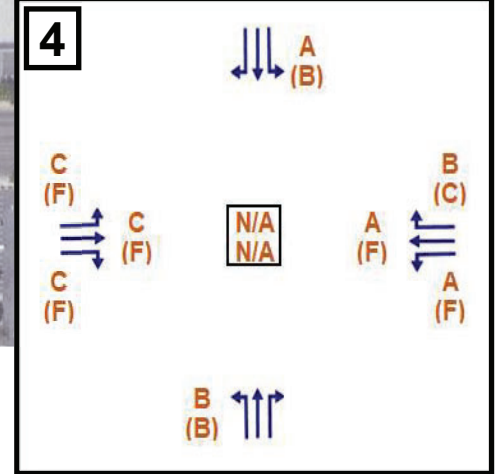

**LEGEND**  
 xx AM Peak Hour Level of Service  
 (xx) PM Peak Hour Level of Service

Harbor Blvd/Orangethorpe Ave

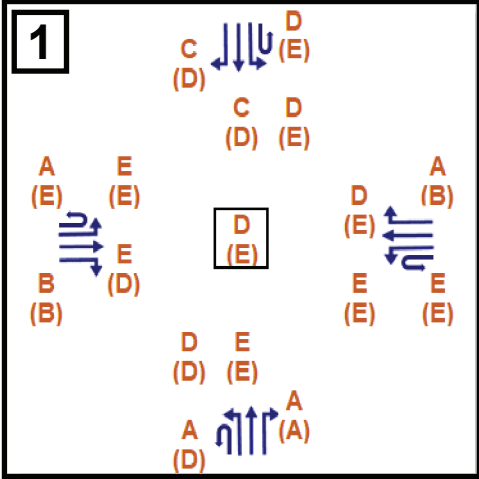

Lemon St/Liberty Ave

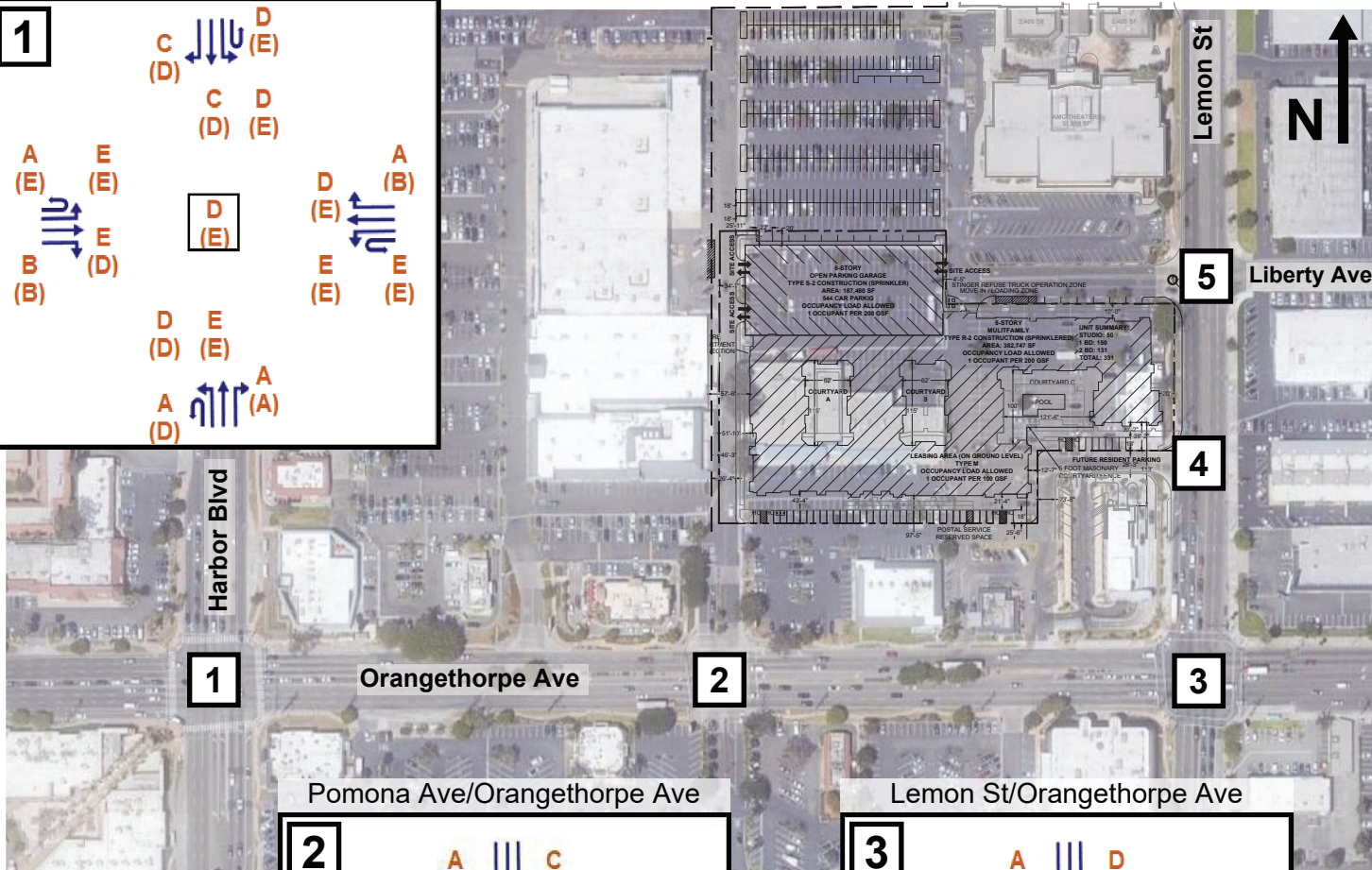
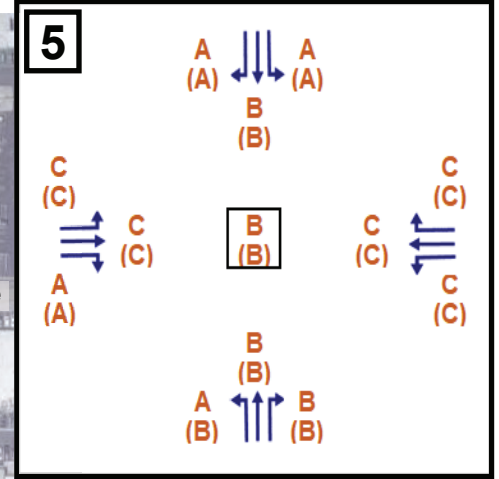

1

Orangethorpe Ave

2

3

Pomona Ave/Orangethorpe Ave

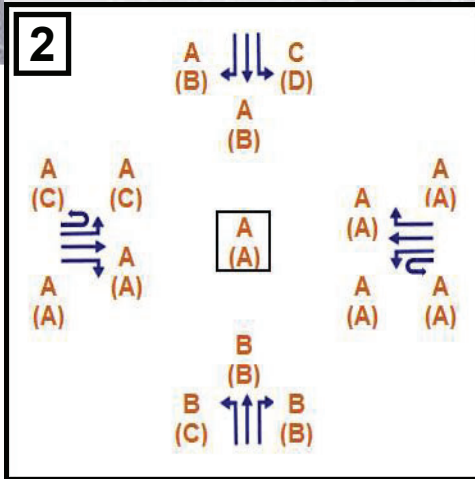

Lemon St/Orangethorpe Ave

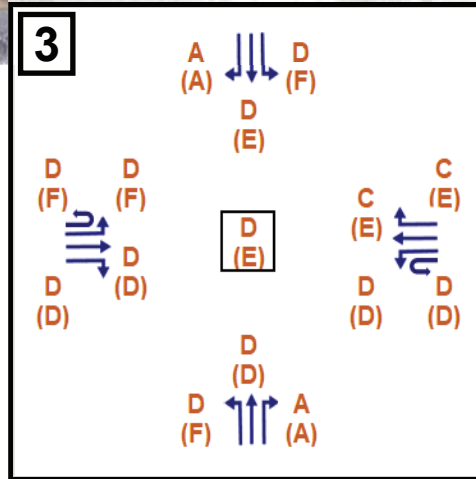

Lemon St/Project Driveway

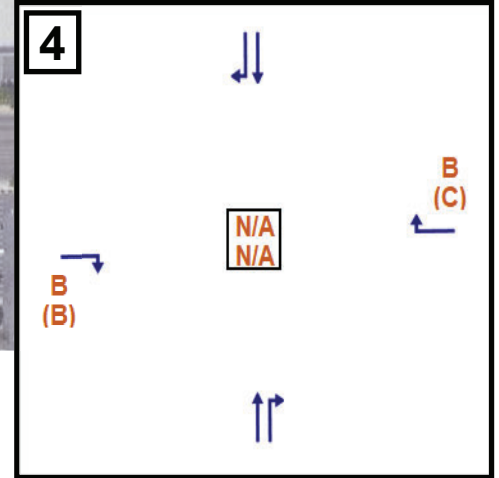

4

**LEGEND**  
 xx AM Peak Hour Level of Service  
 (xx) PM Peak Hour Level of Service



**Table 4. Opening Year Peak Hour Intersection Analysis**

Intersection	Min. LOS	Peak Period	Control Type*	Without Project		Plus Project		Change in Delay	Effect on Transp.?
				Delay (sec/veh)**	LOS	Delay (sec/veh)**	LOS		
1 Orangethorpe Ave/Harbor Blvd	D	AM	S	45.9	D	46.7	D	0.8	No
		PM		57.5	E	57.6	E	0.1	No
2 Orangethorpe Ave/Pomona Ave	D	AM	S	5.2	A	5.5	A	0.3	No
		PM		9.4	A	9.7	A	0.3	No
3 Orangethorpe Ave/Lemon St	D	AM	S	41.7	D	42.1	D	0.4	No
		PM		62.3	E	63.3	E	1.0	No
4 Project Driveway/Lemon St	D	AM	U	0.4	A	0.4	A	0.0	No
		PM		7.5	A	0.8	A	-6.7	No
5 Liberty Ave/Lemon St	D	AM	U/S***	8.4	A	12.4	B	4.0	No
		PM		37.6	E	14.3	B	-23.3	No

\*S = signalized, U = unsignalized

\*\*Delay is not defined for two-way stop control intersections, but was calculated for the purpose of comparison

\*\*\*Will be signalized with the project

### 4.3. GENERAL PLAN YEAR OPERATIONS

In accordance with the City's TAPP, each of the study intersections were evaluated using the HCM methodology within the Synchro traffic modeling software. The LOS for both the morning and evening peak hours for each study intersection, as well as each movement at each of those intersections, in the general plan year of 2030 without the Project are presented in Figure 17. The LOS analysis results for the general plan year of 2030 with the Project are presented in Figure 18. It is important to note that in Figure 18, the intersection of Lemon Street and Liberty Avenue is provided an intersection level LOS rating because it will be signalized with the Project. The Synchro modeling reports for the opening year are included for reference in Appendix E.

As outlined in Figure 17 and Figure 18, the same three intersections that are expected to operate at an unacceptable level of congestion during the PM peak hour in the opening year are also expected to operate unacceptably in 2030. Those three intersections operating at an acceptable LOS E in the PM peak hour are Orangethorpe Avenue/Harbor Boulevard, Orangethorpe Avenue/Lemon Street, and Liberty Avenue/Lemon Street. As shown in Figure 18, the intersections of Orangethorpe Avenue/Harbor Boulevard and Orangethorpe Avenue/Lemon Street are expected to continue to operate at LOS E with the Project.



Harbor Blvd/Orangethorpe Ave

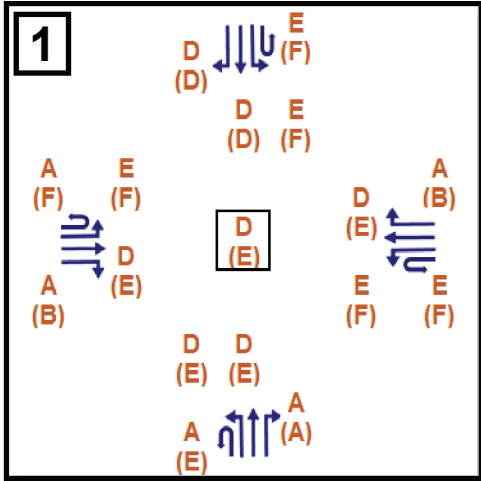

Lemon St/Liberty Ave

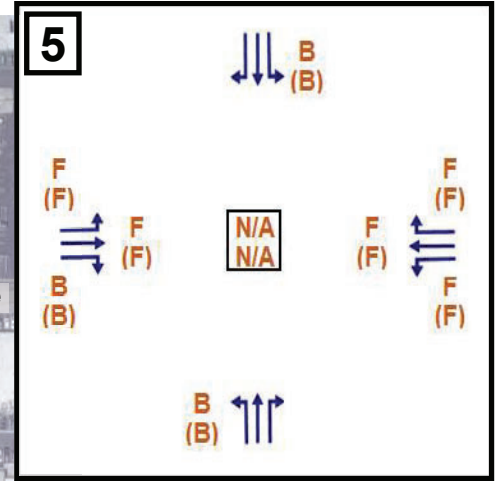

1

Orangethorpe Ave

2

3

4

5

Pomona Ave/Orangethorpe Ave

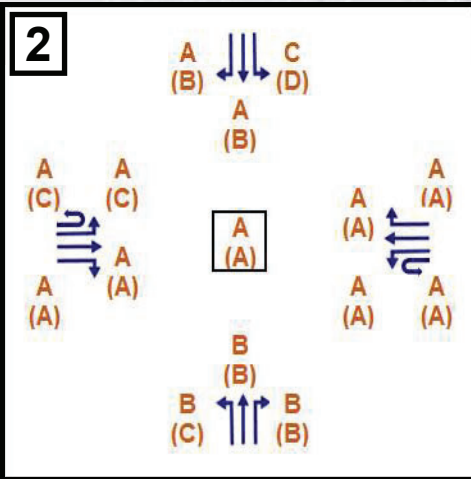

Lemon St/Orangethorpe Ave

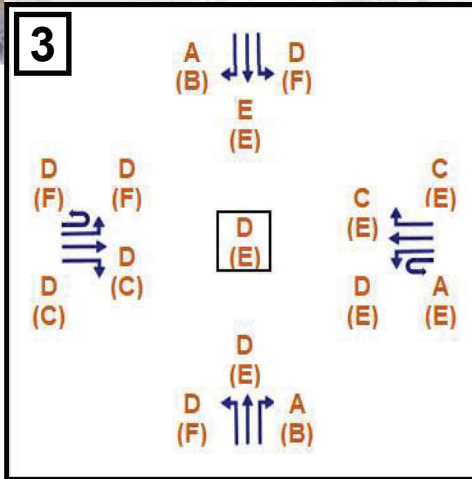

Lemon St/Project Driveway

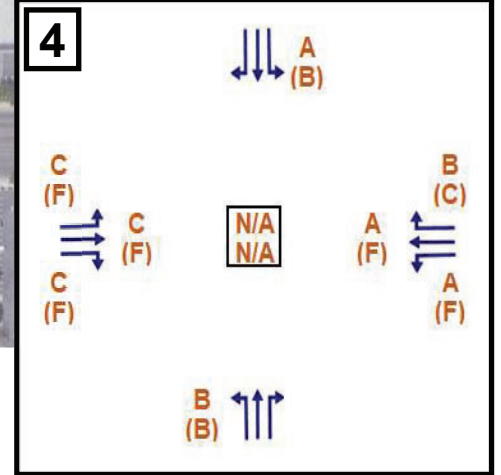

**LEGEND**  
 xx AM Peak Hour Level of Service  
 (xx) PM Peak Hour Level of Service

Harbor Blvd/Orangethorpe Ave

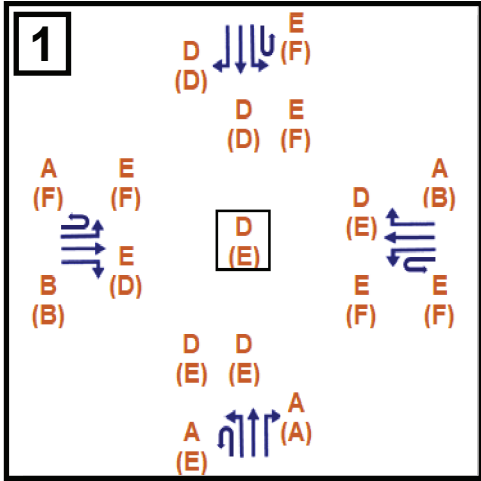

Lemon St/Liberty Ave

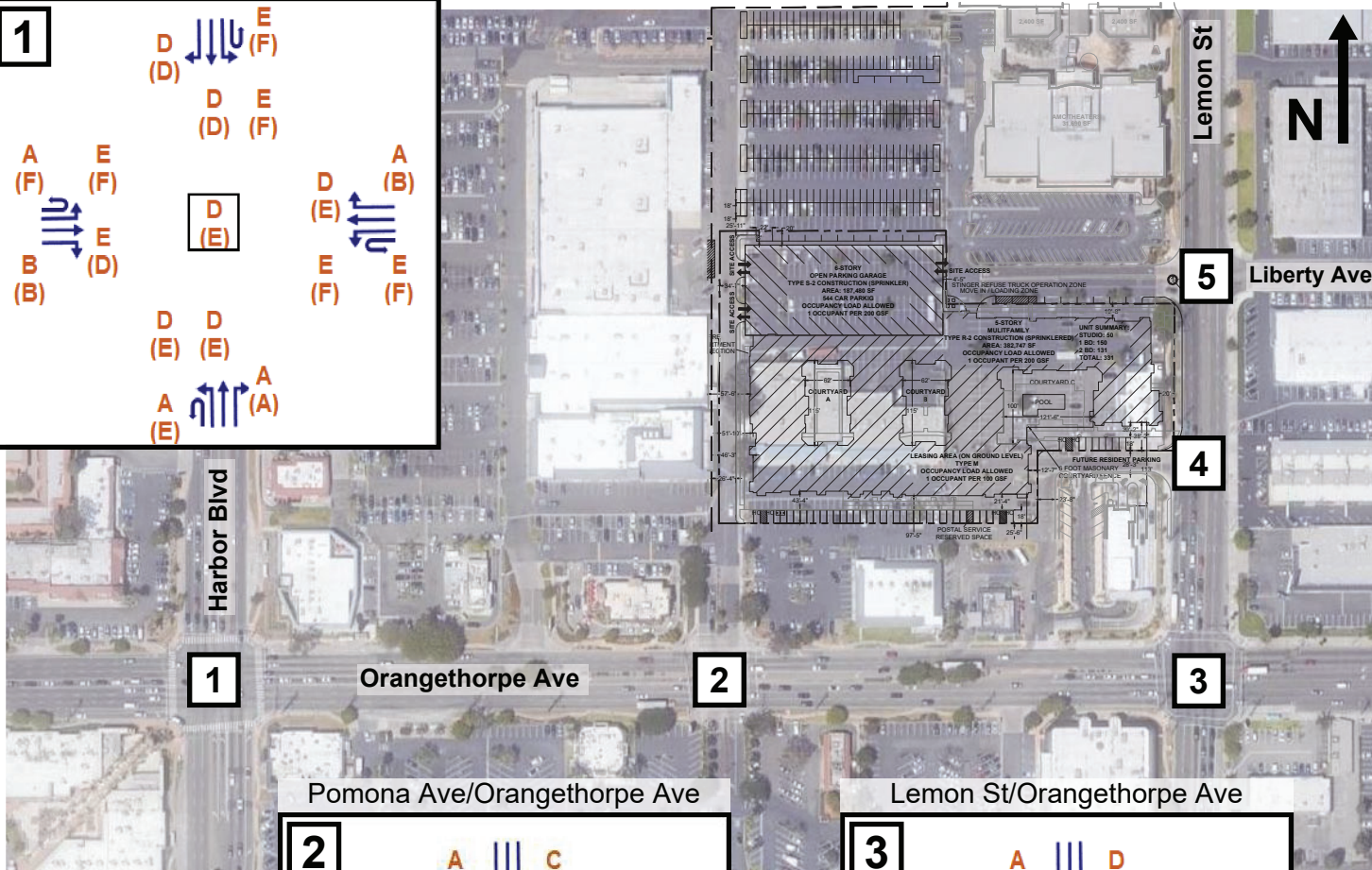
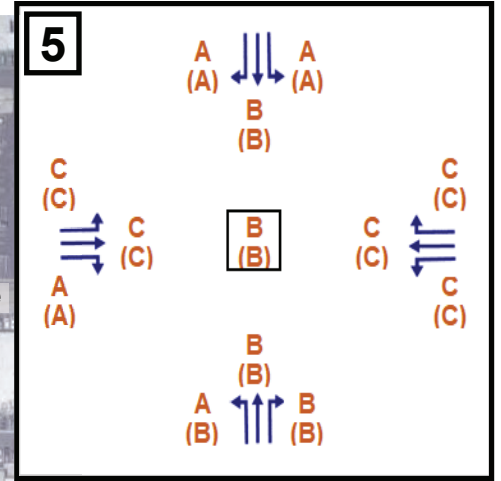

1

Orangethorpe Ave

2

3

Pomona Ave/Orangethorpe Ave

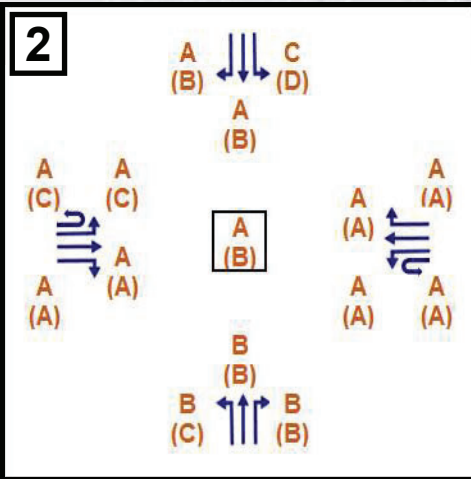

Lemon St/Orangethorpe Ave

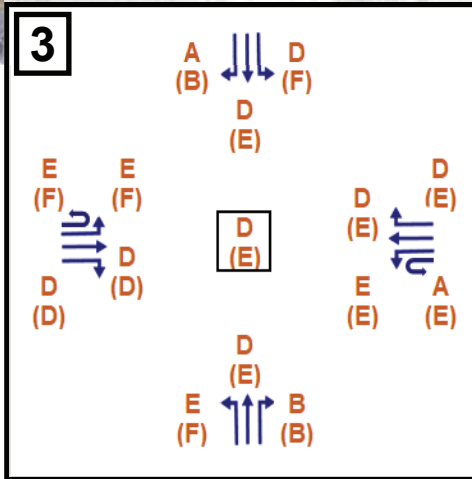

Lemon St/Project Driveway

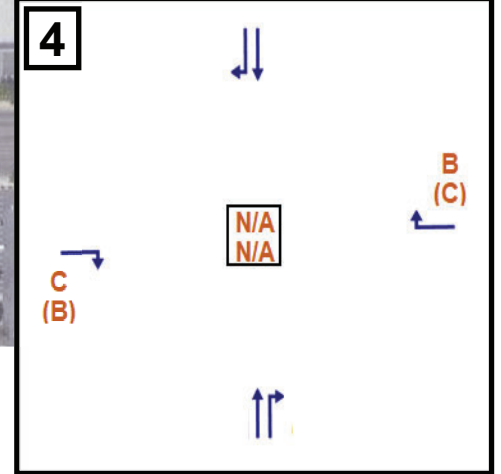

**LEGEND**  
 xx AM Peak Hour Level of Service  
 (xx) PM Peak Hour Level of Service



However, the Liberty Avenue/Lemon Street intersection will improve to LOS B with the installation of a traffic signal associated with the Project.

Table 5 presents a comparison of general plan year 2030 study intersection operations both with and without the Project. Although it is anticipated that vehicle delays at the three intersections along Orangethorpe Avenue will worsen slightly with the implementation of the Project, the anticipated increase in delay associated with the Project falls below the level that could be considered as causing a detrimental effect on traffic operations. Therefore, in accordance with the City's TAPP, it is concluded that the Project itself will not unduly worsen traffic operations in the general plan year and thus no further traffic improvements are necessary or required beyond those already planned with the Project.

**Table 5. General Plan Year Peak Hour Intersection Analysis**

Intersection	Min. LOS	Peak Period	Control Type*	Without Project		Plus Project		Change in Delay	Effect on Transp.?
				Delay (sec/veh)**	LOS	Delay (sec/veh)**	LOS		
1 Orangethorpe Ave/Harbor Blvd	D	AM	S	45.9	D	43.9	D	-2.0	No
		PM		57	E	57.9	E	0.9	No
2 Orangethorpe Ave/Pomona Ave	D	AM	S	5.3	A	6.1	A	0.8	No
		PM		10	A	10.4	B	0.4	No
3 Orangethorpe Ave/Lemon St	D	AM	S	40.7	D	43.4	D	2.7	No
		PM		69.9	E	71.0	E	1.1	No
4 Project Driveway/Lemon St	D	AM	U	0.5	A	0.4	A	-0.1	No
		PM		9.3	A	0.8	A	-8.5	No
5 Liberty Ave/Lemon St	D	AM	U/S***	10.6	B	13.0	B	2.4	No
		PM		46.9	E	14.7	B	-32.2	No

\*S = signalized, U = unsignalized

\*\*Delay is not defined for two-way stop control intersections, but was calculated for the purpose of comparison

\*\*\*Will be signalized with the project



## 5. VEHICLE MILES TRAVELED

The City's TAPP calls for a Vehicle Miles Traveled (VMT) Assessment for all projects in accordance with the California Environmental Quality Act (CEQA). The VMT Assessment required for this project is not a part of this report, but has been conducted and reported separately by the City Traffic Engineer. The VMT Assessment is included in Appendix F.

The City's TAPP sets certain criteria for the evaluation of projects and the conduct of such VMT Assessments. Because the Project is located in a Transit Priority Area and is expected to result in a net reduction of daily trips to and from the site as is outlined in this document, the City Traffic Engineer has determined that it is also likely that the implementation of the Project would result in a net reduction in vehicle miles traveled; therefore, no further VMT study or analysis is required. In accordance with the City's TAPP, the Project is therefore, assumed to have no significant CEQA-related transportation impacts and thus is exempt from the conduct of any further analysis.

## 6. CEQA ANALYSES

In addition to the VMT analysis, the City's TAPP requires analysis of active transportation, site access, and construction conditions. The following sections provided those analyses.

### 6.1. ACTIVE TRANSPORTATION AND PUBLIC TRANSIT ANALYSIS

With the Project, the only anticipated changes to the roadway network will be the widening of Lemon Street south of Liberty Avenue to provide a right turn lane into the site and the construction of a traffic signal at Lemon Street and Liberty Avenue. The existing sidewalk along the west side of Lemon Street will be reconstructed as needed with the project. The new traffic signal will provide a new signalized crossing opportunity for pedestrians and cyclists near the north end of the Project and existing shopping center. There will not be any other changes to the roadway network in the area, and therefore, there will not be any impacts to the existing bicycle, pedestrian, or transit infrastructure. The Project will not preclude proposed improvements to the network, such as those detailed in the *City of Fullerton Bicycle Master Plan*<sup>8</sup>. Lastly, the Project will include sidewalks throughout as well as wide pedestrian plaza areas.

### 6.2. SITE ACCESS ANALYSIS

As previously discussed, the existing northbound and southbound left turn movements from Lemon Street at the Project Driveway will be eliminated with the project. The construction of a new traffic signal at the Lemon Street/Liberty Avenue intersection will include a new striped median which will carry through the Project Driveway intersection, precluding left turn movements at that location. There will not be any other changes to allowable movements at any of the project access locations.

The proposed southbound right turn lane on Lemon Street at the Project Driveway has been evaluated in the design phase, including verification of turning paths. Because no other changes are being made to the project access intersections, there are no anticipated changes to sight visibility or vehicle travel paths. In addition, the City Traffic Engineer did not indicate that any further site access analysis would be required beyond the operational analyses discussed earlier in this report.

### **6.3. CONSTRUCTION-RELATED TRAFFIC IMPACTS**

Construction activities for the Project, including staging and laydown areas and worker parking, will occur on site. Per the City's permitted hours for construction, activities will occur for eight hours per day, six days per week. Construction vehicles and light trucks will access the site from Orangethorpe Avenue, and heavy trucks will follow City-designated haul routes while avoiding residential streets. The use of truck routes will comply with *The Fullerton Plan*.

Demolition activities are expected to generate 500 total truck trips over a 4-month period. Grading and excavation activities will generate 1,000 truck trips over 6 months and building construction will generate 3,000 truck trips over 16-17 months. Construction traffic volumes during the peak hours and on a daily basis are expected to be lower than the traffic volumes at buildout of the Project; therefore, because the Project is not expected to have any effects on transportation in the study area, it is assumed that construction activities will also not have any operational effects on transportation.

Lastly, while construction activities of the Project itself will be contained within the site, the construction of improvements on Lemon Street may require some traffic control and other restrictions. However, fire/emergency access will be maintained to the site in compliance with California and Fullerton Fire Codes, as applicable.



## 7. CONCLUSION

The proposed Street Lights Fullerton Project will replace approximately 15,700 square feet of existing retail shops and restaurants with 329 multi-family units, 6,500 square feet of retail, and a 560-space parking structure. The Project is anticipated to result in a net reduction of 222 daily trips; however, the Project is expected to result in an increase of 103 AM peak hour trips and 48 PM peak hour trips. To improve traffic operations and access to the site, the Project will also widen and restripe Lemon Street to add turn lanes and will signalize the intersection of Lemon Street and Liberty Avenue.

Based on the LOS analyses at the five study intersections, it was discovered that the intersection of Orangethorpe Avenue and Lemon Street currently operates at an unacceptable LOS E during the PM peak hour. Furthermore, considering anticipated traffic growth in the area the intersection of Orangethorpe Avenue and Harbor Boulevard is also likely to operate at an unacceptable LOS in the opening year and in the general plan year of 2030 without consideration of the Project. Although it is anticipated that vehicle delays at both intersections will worsen slightly with the implementation of the Project, the anticipated increase in vehicle delay because of the Project falls below the level that could be considered as causing a detrimental effect on traffic operations.

The LOS analysis also revealed that the intersection of Lemon Street and Liberty Avenue would operate at an unacceptable level of service during the PM peak hour both in the opening year and the general plan year. However, with the proposed signalization of the intersection as part of the Project, traffic operations will improve significantly to LOS A.

Therefore, in accordance with the City's TAPP, it is concluded that the Project itself will not unduly worsen traffic operations in the opening year or in the general plan year (2030) and thus, no further traffic improvements are necessary or required beyond those already planned with the Project.

Conduct of a VMT Assessment by the City Traffic Engineer determined that it is likely that the implementation of the Project would result in a net reduction in vehicle miles traveled; therefore, it is assumed that the Project has no significant CEQA-related transportation impacts and no further VMT study or analysis is required.

## 8. REFERENCES

- 
- <sup>1</sup> *Transportation Assessment Policies and Procedures*. City of Fullerton, June 2020.
  - <sup>2</sup> *Highway Capacity Manual, 6<sup>th</sup> Edition*. Transportation Research Board, October 2016.
  - <sup>3</sup> *California Manual on Uniform Traffic Control Devices, Revision 6*. Caltrans, March 2021.
  - <sup>4</sup> *The Fullerton Plan, 2030*. City of Fullerton, 2012.
  - <sup>5</sup> *Connect SoCal Demographics and Growth Forecast*. Southern California Association of Governments, Adopted September 2020.
  - <sup>6</sup> *City of Fullerton General Plan Update, Transportation and Circulation Existing and Build-out Conditions Report*. Kimley-Horn and Associates, Inc., September 2011.
  - <sup>7</sup> *Trip Generation, 10<sup>th</sup> Edition*. Institute of Transportation Engineers (ITE). Washington, D.C., 2017.
  - <sup>8</sup> *Fullerton Bicycle Master Plan*. City of Fullerton, May 2012.

## Appendix A – Traffic Volume Data (2019 and 2021)



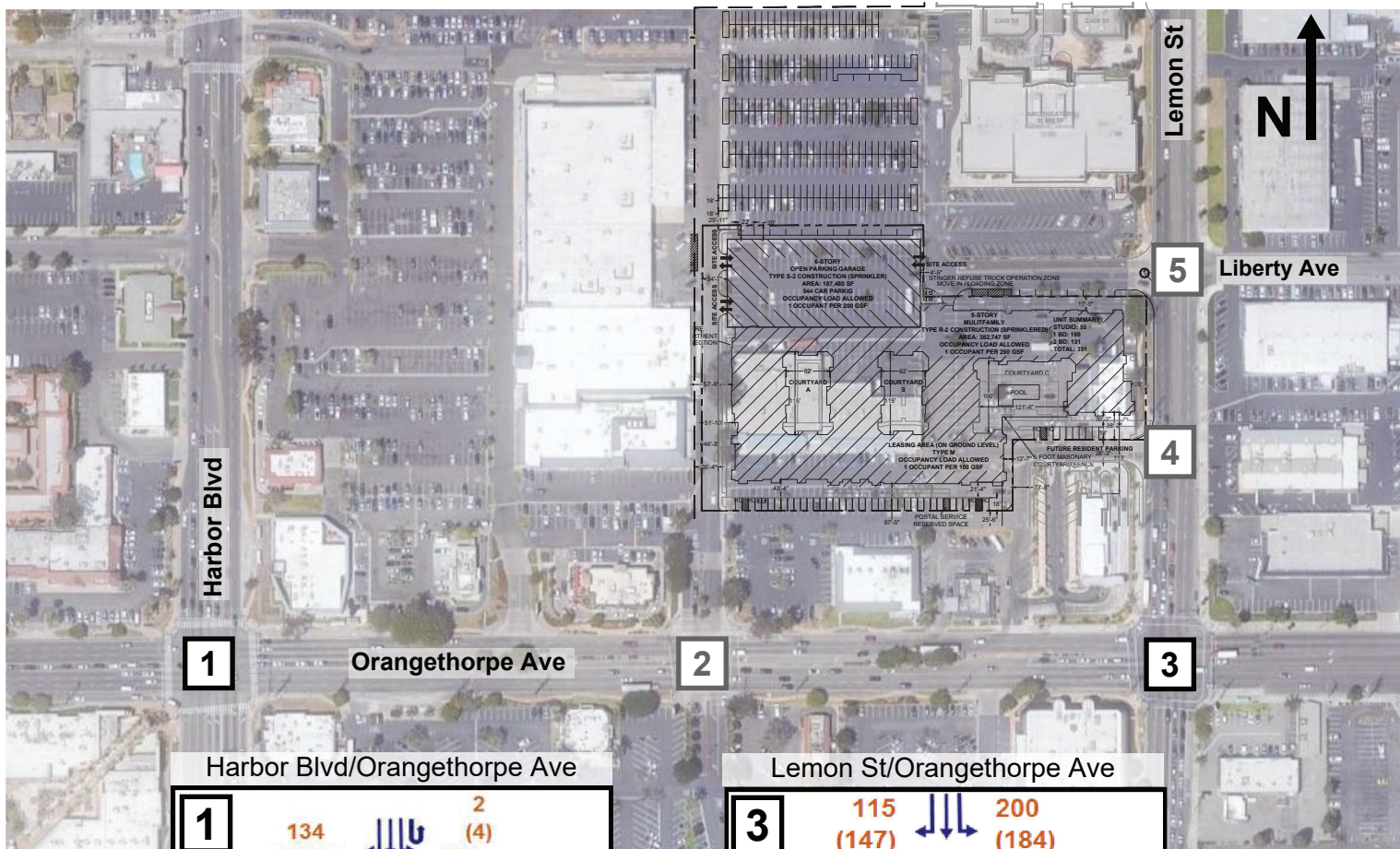

Harbor Blvd/Orangethorpe Ave

<b>1</b>	134 (208)	↓ ↓ ↓	2 (4)
			179 (177)
		1,396 (1131)	
0 (2)	210 (210)		85 (186)
↑ ↑ ↑	1,197 (820)		433 (956)
255 (201)			112 (195)
			1 (11)
	88 (289)		849 (1120)
	0 (1)	↑ ↑ ↑	167 (239)

Lemon St/Orangethorpe Ave

<b>3</b>	115 (147)	↓ ↓ ↓	200 (184)
			826 (873)
219 (197)			106 (131)
↑ ↑ ↑	1,115 (800)		430 (825)
170 (176)			106 (251)
			833 (1038)
	120 (240)	↑ ↑ ↑	138 (96)

**LEGEND**  
 xx AM Peak Hour Traffic Volume (veh/hr)  
 (xx) PM Peak Hour Traffic Volume (veh/hr)

# National Data & Surveying Services Intersection Turning Movement Count

**Location:** Harbor Blvd & Orangethorpe Ave  
**City:** Fullerton  
**Control:** Signalized

**Project ID:** 21-010011-001  
**Date:** 2/25/2021

## Data - Total

NS/EW Streets:	Harbor Blvd				Harbor Blvd				Orangethorpe Ave				Orangethorpe Ave				TOTAL
	NORTHBOUND				SOUTHBOUND				EASTBOUND				WESTBOUND				
AM	2	2	1	0	2	2.5	0.5	0	1	3	1	0	1	3	1	0	
	NL	NT	NR	NU	SL	ST	SR	SU	EL	ET	ER	EU	WL	WT	WR	WU	
7:00 AM	10	123	31	0	28	180	10	1	32	108	32	0	14	53	17	2	641
7:15 AM	19	188	25	0	22	225	17	0	20	94	40	0	14	65	23	0	752
7:30 AM	18	192	29	0	43	233	18	1	37	144	29	0	20	58	26	1	849
7:45 AM	18	198	36	0	34	232	14	1	28	153	30	0	23	70	35	0	872
8:00 AM	16	162	25	0	21	197	18	0	23	101	36	0	26	79	22	1	727
8:15 AM	18	191	20	0	21	259	29	1	29	114	32	0	22	92	20	0	848
8:30 AM	14	181	33	0	35	227	16	2	32	106	21	0	20	88	25	0	800
8:45 AM	12	195	29	0	31	187	24	1	37	122	30	0	31	82	28	1	810
<b>TOTAL VOLUMES :</b>	NL	NT	NR	NU	SL	ST	SR	SU	EL	ET	ER	EU	WL	WT	WR	WU	TOTAL
<b>APPROACH %'s :</b>	7.01%	80.20%	12.79%	0.00%	11.04%	81.77%	6.86%	0.33%	16.64%	65.87%	17.48%	0.00%	17.75%	61.27%	20.46%	0.52%	6299
<b>PEAK HR :</b>	<b>07:30 AM - 08:30 AM</b>																<b>TOTAL</b>
<b>PEAK HR VOL :</b>	70	743	110	0	119	921	79	3	117	512	127	0	91	299	103	2	3296
<b>PEAK HR FACTOR :</b>	0.972	0.938	0.764	0.000	0.692	0.889	0.681	0.750	0.791	0.837	0.882	0.000	0.875	0.813	0.736	0.500	0.945
	0.916				0.905				0.896				0.924				
PM	NORTHBOUND				SOUTHBOUND				EASTBOUND				WESTBOUND				TOTAL
	2	2	1	0	2	2.5	0.5	0	1	3	1	0	1	3	1	0	
	NL	NT	NR	NU	SL	ST	SR	SU	EL	ET	ER	EU	WL	WT	WR	WU	
4:00 PM	49	230	59	0	35	251	35	3	49	167	42	0	49	204	48	1	1222
4:15 PM	43	260	28	1	47	232	38	1	55	215	35	0	48	210	37	2	1252
4:30 PM	58	245	45	0	36	236	42	2	44	145	48	0	50	221	51	4	1227
4:45 PM	56	273	49	0	44	252	53	3	58	173	32	0	51	201	51	4	1300
5:00 PM	55	271	49	1	44	280	51	3	49	172	45	1	52	227	45	3	1348
5:15 PM	50	274	60	0	46	299	43	2	55	185	40	1	49	214	46	2	1366
5:30 PM	56	286	49	0	50	246	47	4	57	198	50	0	50	231	39	5	1368
5:45 PM	46	259	47	0	39	245	40	2	50	175	47	1	54	222	46	1	1274
<b>TOTAL VOLUMES :</b>	NL	NT	NR	NU	SL	ST	SR	SU	EL	ET	ER	EU	WL	WT	WR	WU	TOTAL
<b>APPROACH %'s :</b>	14.25%	72.37%	13.31%	0.07%	12.40%	74.19%	12.69%	0.73%	19.05%	65.33%	15.49%	0.14%	16.00%	68.71%	14.42%	0.87%	10357
<b>PEAK HR :</b>	<b>04:45 PM - 05:45 PM</b>																<b>TOTAL</b>
<b>PEAK HR VOL :</b>	217	1104	207	1	184	1077	194	12	219	728	167	2	202	873	181	14	5382
<b>PEAK HR FACTOR :</b>	0.969	0.965	0.863	0.250	0.920	0.901	0.915	0.750	0.944	0.919	0.835	0.500	0.971	0.945	0.887	0.700	0.984
	0.978				0.940				0.915				0.971				

# National Data & Surveying Services

## Intersection Turning Movement Count

**Location:** Pomona Ave & Orangethorpe Ave  
**City:** Fullerton  
**Control:** Signalized

**Project ID:** 21-010011-002  
**Date:** 3/3/2021

### Total

NS/EW Streets:	Pomona Ave				Pomona Ave				Orangethorpe Ave				Orangethorpe Ave				
AM	NORTHBOUND				SOUTHBOUND				EASTBOUND				WESTBOUND				TOTAL
	1 NL	1 NT	0 NR	0 NU	1 SL	1 ST	0 SR	0 SU	1 EL	3 ET	0 ER	0 EU	1 WL	2 WT	1 WR	0 WU	
7:00 AM	11	2	3	0	5	0	5	0	8	148	8	0	2	78	14	1	285
7:15 AM	6	2	2	0	7	0	5	0	11	137	4	0	2	92	10	3	281
7:30 AM	6	2	4	0	11	1	10	0	12	172	6	0	4	104	11	3	346
7:45 AM	10	5	3	0	11	0	6	0	17	208	7	0	4	94	10	3	378
8:00 AM	4	3	1	0	14	0	6	0	17	167	9	1	5	112	17	1	357
8:15 AM	13	1	8	0	8	3	17	0	12	143	8	0	1	102	14	5	335
8:30 AM	7	2	1	0	10	3	14	0	14	146	12	0	1	109	21	4	344
8:45 AM	9	3	5	0	10	5	12	0	21	137	5	3	6	112	21	5	354
TOTAL VOLUMES :	NL	NT	NR	NU	SL	ST	SR	SU	EL	ET	ER	EU	WL	WT	WR	WU	TOTAL
	66	20	27	0	76	12	75	0	112	1258	59	4	25	803	118	25	2680
APPROACH %'s :	58.41%	17.70%	23.89%	0.00%	46.63%	7.36%	46.01%	0.00%	7.82%	87.79%	4.12%	0.28%	2.57%	82.70%	12.15%	2.57%	
PEAK HR :	07:30 AM - 08:30 AM																TOTAL
PEAK HR VOL :	33	11	16	0	44	4	39	0	58	690	30	1	14	412	52	12	1416
PEAK HR FACTOR :	0.635	0.550	0.500	0.000	0.786	0.333	0.574	0.000	0.853	0.829	0.833	0.250	0.700	0.920	0.765	0.600	0.937
	0.682				0.777				0.839				0.907				

PM	NORTHBOUND				SOUTHBOUND				EASTBOUND				WESTBOUND				TOTAL
	1 NL	1 NT	0 NR	0 NU	1 SL	1 ST	0 SR	0 SU	1 EL	3 ET	0 ER	0 EU	1 WL	2 WT	1 WR	0 WU	
4:00 PM	24	6	15	0	37	6	18	0	40	199	17	2	17	229	28	1	639
4:15 PM	28	7	19	0	36	9	25	0	41	232	21	0	16	183	31	0	648
4:30 PM	27	9	20	0	34	12	22	0	25	196	26	3	17	199	38	3	631
4:45 PM	20	9	13	0	33	8	24	1	40	192	20	1	10	204	37	5	617
5:00 PM	21	5	16	0	32	11	21	0	32	171	13	0	13	219	38	3	595
5:15 PM	20	11	14	0	32	6	24	0	34	157	22	0	11	216	30	2	579
5:30 PM	16	8	23	0	32	6	21	0	40	186	15	3	10	163	34	0	557
5:45 PM	21	5	14	0	39	6	23	0	37	157	18	4	18	163	31	1	537
TOTAL VOLUMES :	NL	NT	NR	NU	SL	ST	SR	SU	EL	ET	ER	EU	WL	WT	WR	WU	TOTAL
	177	60	134	0	275	64	178	1	289	1490	152	13	112	1576	267	15	4803
APPROACH %'s :	47.71%	16.17%	36.12%	0.00%	53.09%	12.36%	34.36%	0.19%	14.87%	76.65%	7.82%	0.67%	5.69%	80.00%	13.55%	0.76%	
PEAK HR :	04:00 PM - 05:00 PM																TOTAL
PEAK HR VOL :	99	31	67	0	140	35	89	1	146	819	84	6	60	815	134	9	2535
PEAK HR FACTOR :	0.884	0.861	0.838	0.000	0.946	0.729	0.890	0.250	0.890	0.883	0.808	0.500	0.882	0.890	0.882	0.450	0.978
	0.879				0.946				0.897				0.925				



# National Data & Surveying Services Intersection Turning Movement Count

**Location:** Lemon St & Orangethorpe Ave  
**City:** Fullerton  
**Control:** Signalized

**Project ID:** 21-010011-003  
**Date:** 2/25/2021

## Data - Total

NS/EW Streets:	Lemon St				Lemon St				Orangethorpe Ave				Orangethorpe Ave				
AM	NORTHBOUND				SOUTHBOUND				EASTBOUND				WESTBOUND				TOTAL
	1 NL	2 NT	1 NR	0 NU	1 SL	2 ST	1 SR	0 SU	1 EL	3 ET	0 ER	0 EU	2 WL	2 WT	0 WR	0 WU	
7:00 AM	24	79	23	0	21	108	11	0	16	110	37	0	14	59	11	0	513
7:15 AM	36	109	25	0	29	101	9	0	12	96	35	0	18	60	10	0	540
7:30 AM	26	110	30	0	32	98	7	0	14	168	36	0	17	75	13	0	626
7:45 AM	39	113	38	0	38	125	11	0	12	180	30	0	21	86	15	0	708
8:00 AM	33	107	28	0	25	120	16	0	13	113	20	1	22	76	15	0	589
8:15 AM	38	87	29	0	18	111	11	0	8	109	33	0	23	81	18	0	566
8:30 AM	36	94	30	0	31	113	13	0	23	112	34	1	21	70	11	0	589
8:45 AM	40	145	18	0	20	106	11	0	13	120	42	1	28	88	25	0	657
<b>TOTAL VOLUMES :</b>	NL	NT	NR	NU	SL	ST	SR	SU	EL	ET	ER	EU	WL	WT	WR	WU	TOTAL
<b>APPROACH %'s :</b>	272	844	221	0	214	882	89	0	111	1008	267	3	164	595	118	0	4788
	20.34%	63.13%	16.53%	0.00%	18.06%	74.43%	7.51%	0.00%	7.99%	72.57%	19.22%	0.22%	18.70%	67.84%	13.45%	0.00%	
<b>PEAK HR :</b>	<b>07:30 AM - 08:30 AM</b>																<b>TOTAL</b>
<b>PEAK HR VOL :</b>	136	417	125	0	113	454	45	0	47	570	119	1	83	318	61	0	2489
<b>PEAK HR FACTOR :</b>	0.872	0.923	0.822	0.000	0.743	0.908	0.703	0.000	0.839	0.792	0.826	0.250	0.902	0.924	0.847	0.000	0.879
	0.892				0.879				0.830				0.947				
PM	NORTHBOUND				SOUTHBOUND				EASTBOUND				WESTBOUND				TOTAL
	1 NL	2 NT	1 NR	0 NU	1 SL	2 ST	1 SR	0 SU	1 EL	3 ET	0 ER	0 EU	2 WL	2 WT	0 WR	0 WU	
4:00 PM	50	174	22	0	43	128	18	0	37	176	40	0	54	193	39	0	974
4:15 PM	66	149	35	0	35	137	31	0	47	188	37	0	49	170	39	1	984
4:30 PM	55	158	33	0	38	169	22	0	36	148	38	0	51	186	36	0	970
4:45 PM	64	205	20	0	33	165	25	0	27	167	29	0	44	165	39	2	985
5:00 PM	66	197	29	0	31	147	37	0	44	175	40	2	60	185	35	0	1048
5:15 PM	64	167	23	0	30	154	27	0	46	166	51	0	47	171	33	1	980
5:30 PM	67	188	17	0	50	167	26	0	38	182	55	0	64	177	36	0	1067
5:45 PM	72	205	27	0	35	159	29	0	43	148	44	0	53	162	31	1	1009
<b>TOTAL VOLUMES :</b>	NL	NT	NR	NU	SL	ST	SR	SU	EL	ET	ER	EU	WL	WT	WR	WU	TOTAL
<b>APPROACH %'s :</b>	504	1443	206	0	295	1226	215	0	318	1350	334	2	422	1409	288	5	8017
	23.41%	67.02%	9.57%	0.00%	16.99%	70.62%	12.38%	0.00%	15.87%	67.37%	16.67%	0.10%	19.87%	66.34%	13.56%	0.24%	
<b>PEAK HR :</b>	<b>05:00 PM - 06:00 PM</b>																<b>TOTAL</b>
<b>PEAK HR VOL :</b>	269	757	96	0	146	627	119	0	171	671	190	2	224	695	135	2	4104
<b>PEAK HR FACTOR :</b>	0.934	0.923	0.828	0.000	0.730	0.939	0.804	0.000	0.929	0.922	0.864	0.250	0.875	0.939	0.938	0.500	0.962
	0.923				0.918				0.940				0.943				

# National Data & Surveying Services Intersection Turning Movement Count

**Location:** Lemon St & Liberty Ave  
**City:** Fullerton  
**Control:** 2-Way Stop (EB/WB)

**Project ID:** 21-010011-004  
**Date:** 2/25/2021

## Data - Total

NS/EW Streets:	Lemon St				Lemon St				Liberty Ave				Liberty Ave				
AM	NORTHBOUND				SOUTHBOUND				EASTBOUND				WESTBOUND				TOTAL
	0 NL	2 NT	0 NR	0 NU	0 SL	2 ST	0 SR	0 SU	0 EL	2 ET	0 ER	0 EU	0 WL	1 WT	0 WR	0 WU	
7:00 AM	2	95	17	0	1	117	4	0	3	1	6	0	7	0	2	0	255
7:15 AM	3	111	16	0	5	125	3	0	0	0	7	0	9	0	0	0	279
7:30 AM	7	115	16	0	3	106	2	0	0	0	6	0	10	0	2	0	267
7:45 AM	1	108	15	0	5	166	1	0	2	0	9	0	9	1	2	0	319
8:00 AM	2	120	17	0	5	158	3	0	6	0	11	0	4	0	2	0	328
8:15 AM	3	99	5	1	3	120	4	0	2	0	7	0	6	0	1	0	251
8:30 AM	5	118	15	0	3	134	4	0	2	0	4	0	4	0	1	0	290
8:45 AM	10	134	23	0	3	116	6	0	1	3	10	0	10	0	0	0	316
<b>TOTAL VOLUMES :</b>	33	900	124	1	28	1042	27	0	16	4	60	0	59	1	10	0	2305
<b>APPROACH %'s :</b>	3.12%	85.07%	11.72%	0.09%	2.55%	94.99%	2.46%	0.00%	20.00%	5.00%	75.00%	0.00%	84.29%	1.43%	14.29%	0.00%	
<b>PEAK HR :</b>	<b>07:15 AM - 08:15 AM</b>																<b>TOTAL</b>
<b>PEAK HR VOL :</b>	13	454	64	0	18	555	9	0	8	0	33	0	32	1	6	0	1193
<b>PEAK HR FACTOR :</b>	0.464	0.946	0.941	0.000	0.900	0.836	0.750	0.000	0.333	0.000	0.750	0.000	0.800	0.250	0.750	0.000	0.909
	0.955				0.846				0.603				0.813				
PM	NORTHBOUND				SOUTHBOUND				EASTBOUND				WESTBOUND				TOTAL
	0 NL	2 NT	0 NR	0 NU	0 SL	2 ST	0 SR	0 SU	0 EL	2 ET	0 ER	0 EU	0 WL	1 WT	0 WR	0 WU	
4:00 PM	21	215	8	0	3	155	9	0	9	0	14	0	13	0	10	0	457
4:15 PM	21	207	8	0	0	145	12	0	7	0	28	0	13	0	3	0	444
4:30 PM	18	220	1	0	0	185	10	0	13	0	20	0	15	0	5	0	487
4:45 PM	30	222	2	1	0	200	9	0	12	0	18	0	6	0	0	0	500
5:00 PM	20	248	6	0	1	169	18	0	11	0	16	0	12	1	12	0	514
5:15 PM	21	235	0	1	0	173	23	0	16	0	14	0	4	0	2	0	489
5:30 PM	29	227	1	0	0	182	7	0	10	0	25	0	6	0	4	0	491
5:45 PM	27	257	0	0	0	188	15	0	13	0	28	0	9	0	2	0	539
<b>TOTAL VOLUMES :</b>	187	1831	26	2	4	1397	103	0	91	0	163	0	78	1	38	0	3921
<b>APPROACH %'s :</b>	9.14%	89.49%	1.27%	0.10%	0.27%	92.89%	6.85%	0.00%	35.83%	0.00%	64.17%	0.00%	66.67%	0.85%	32.48%	0.00%	
<b>PEAK HR :</b>	<b>05:00 PM - 06:00 PM</b>																<b>TOTAL</b>
<b>PEAK HR VOL :</b>	97	967	7	1	1	712	63	0	50	0	83	0	31	1	20	0	2033
<b>PEAK HR FACTOR :</b>	0.836	0.941	0.292	0.250	0.250	0.947	0.685	0.000	0.781	0.000	0.741	0.000	0.646	0.250	0.417	0.000	0.943
	0.944				0.956				0.811				0.520				

# National Data & Surveying Services Intersection Turning Movement Count

**Location:** Lemon St & Anaheim Feed & Pet Supply Dwy/Hot Wok Restaurant Dwy  
**City:** Fullerton  
**Control:** 1-Way Stop (EB)

**Project ID:** 21-010011-005  
**Date:** 2/25/2021

## Data - Total

NS/EW Streets:	Lemon St				Lemon St				Anaheim Feed & Pet Supply Dwy/Hot Wok Restaurant Dwy				Anaheim Feed & Pet Supply Dwy/Hot Wok Restaurant Dwy				TOTAL
	NORTHBOUND				SOUTHBOUND				EASTBOUND				WESTBOUND				
AM	0	2	0	0	0	2	0	0	0	1	0	0	0	2	0	0	TOTAL
	NL	NT	NR	NU	SL	ST	SR	SU	EL	ET	ER	EU	WL	WT	WR	WU	
7:00 AM	0	111	0	0	0	135	1	0	0	0	4	0	0	0	0	0	251
7:15 AM	0	129	0	0	0	131	1	0	0	0	1	0	0	0	0	0	262
7:30 AM	0	143	0	0	0	137	3	0	0	0	5	0	0	0	0	0	288
7:45 AM	1	133	0	0	0	167	4	0	0	0	6	0	0	0	0	0	311
8:00 AM	1	135	1	0	0	154	6	0	1	0	5	0	0	0	1	0	304
8:15 AM	0	111	1	0	0	139	2	0	0	0	9	0	0	0	1	0	263
8:30 AM	1	132	0	0	0	149	2	0	1	0	8	0	0	0	0	0	293
8:45 AM	1	173	3	0	3	123	1	0	0	0	7	0	1	0	2	0	314
<b>TOTAL VOLUMES :</b>	NL	NT	NR	NU	SL	ST	SR	SU	EL	ET	ER	EU	WL	WT	WR	WU	TOTAL
<b>APPROACH %'s :</b>	4	1067	5	0	3	1135	20	0	2	0	45	0	1	0	4	0	2286
	0.37%	99.16%	0.46%	0.00%	0.26%	98.01%	1.73%	0.00%	4.26%	0.00%	95.74%	0.00%	20.00%	0.00%	80.00%	0.00%	
<b>PEAK HR :</b>	<b>08:00 AM - 09:00 AM</b>																<b>TOTAL</b>
<b>PEAK HR VOL :</b>	3	551	5	0	3	565	11	0	2	0	29	0	1	0	4	0	1174
<b>PEAK HR FACTOR :</b>	0.750	0.796	0.417	0.000	0.250	0.917	0.458	0.000	0.500	0.000	0.806	0.000	0.250	0.000	0.500	0.000	0.935
	0.790				0.905				0.861				0.417				
PM	0	2	0	0	0	2	0	0	0	1	0	0	0	2	0	0	TOTAL
	NL	NT	NR	NU	SL	ST	SR	SU	EL	ET	ER	EU	WL	WT	WR	WU	
4:00 PM	3	230	10	0	2	183	4	0	1	1	9	0	6	0	6	0	455
4:15 PM	1	227	11	1	4	180	2	0	3	1	13	0	6	0	8	0	457
4:30 PM	3	222	4	0	5	216	8	0	2	0	11	0	6	0	9	0	486
4:45 PM	2	255	9	0	3	212	6	0	3	0	9	0	3	0	5	0	507
5:00 PM	3	270	11	0	3	191	5	0	2	0	16	0	9	0	4	0	514
5:15 PM	5	237	3	0	3	190	5	0	3	1	19	0	7	0	9	0	482
5:30 PM	1	252	10	1	4	217	0	0	1	1	15	0	2	1	3	0	508
5:45 PM	4	275	6	0	1	211	6	0	1	0	14	0	6	0	9	0	533
<b>TOTAL VOLUMES :</b>	NL	NT	NR	NU	SL	ST	SR	SU	EL	ET	ER	EU	WL	WT	WR	WU	TOTAL
<b>APPROACH %'s :</b>	22	1968	64	2	25	1600	36	0	16	4	106	0	45	1	53	0	3942
	1.07%	95.72%	3.11%	0.10%	1.51%	96.33%	2.17%	0.00%	12.70%	3.17%	84.13%	0.00%	45.45%	1.01%	53.54%	0.00%	
<b>PEAK HR :</b>	<b>05:00 PM - 06:00 PM</b>																<b>TOTAL</b>
<b>PEAK HR VOL :</b>	13	1034	30	1	11	809	16	0	7	2	64	0	24	1	25	0	2037
<b>PEAK HR FACTOR :</b>	0.650	0.940	0.682	0.250	0.688	0.932	0.667	0.000	0.583	0.500	0.842	0.000	0.667	0.250	0.694	0.000	0.955
	0.946				0.946				0.793				0.781				

## Appendix B – HCM/Synchro Reports – Existing Conditions



Lanes, Volumes, Timings  
1: Harbor Boulevard & Orangethorpe Avenue

05/23/2021



Lane Group	EBL	EBT	EBR	WBU	WBL	WBT	WBR	NBL	NBT	NBR	SBU	SBL
Lane Configurations	↔	↑↑↑	↗		↖	↑↑↑	↗	↔	↑↑	↗		↔
Traffic Volume (vph)	184	807	200	3	143	471	162	110	1171	173	5	188
Future Volume (vph)	184	807	200	3	143	471	162	110	1171	173	5	188
Ideal Flow (vphpl)	1800	1900	1900	1800	1800	1900	1900	1750	1900	1900	1750	1750
Storage Length (ft)	200		130		240		140	120		250		270
Storage Lanes	1		1		1		1	2		0		2
Taper Length (ft)	90				60			90				100
Satd. Flow (prot)	1676	5085	1583	0	1676	5085	1583	3162	3539	1583	0	3162
Flt Permitted	0.950				0.950			0.950				0.950
Satd. Flow (perm)	1676	5085	1583	0	1676	5085	1583	3162	3539	1583	0	3162
Right Turn on Red			Yes				Yes			Yes		
Satd. Flow (RTOR)			205				176			187		
Link Speed (mph)		40				40			40			
Link Distance (ft)		787				701			655			
Travel Time (s)		13.4				11.9			11.2			
Peak Hour Factor	0.92	0.92	0.92	0.92	0.92	0.92	0.92	0.92	0.92	0.92	0.92	0.92
Shared Lane Traffic (%)												
Lane Group Flow (vph)	200	877	217	0	158	512	176	120	1273	188	0	209
Turn Type	Prot	NA	Perm	Prot	Prot	NA	Perm	Prot	NA	Perm	Prot	Prot
Protected Phases	7	4		3	3	8		5	2		1	1
Permitted Phases			4				8			2		
Total Split (s)	18.0	21.0	21.0	18.0	18.0	21.0	21.0	16.0	35.0	35.0	16.0	16.0
Total Lost Time (s)	4.5	4.5	4.5		4.5	4.5	4.5	4.5	4.5	4.5		4.5
Act Effct Green (s)	12.9	16.5	16.5		11.9	15.6	15.6	8.6	30.5	30.5		10.3
Actuated g/C Ratio	0.15	0.19	0.19		0.14	0.18	0.18	0.10	0.35	0.35		0.12
v/c Ratio	0.81	0.91	0.47		0.69	0.56	0.41	0.38	1.03	0.28		0.56
Control Delay	62.4	50.3	9.5		52.6	35.7	8.5	40.7	63.1	4.6		43.0
Queue Delay	0.0	0.0	0.0		0.0	0.0	0.0	0.0	0.0	0.0		0.0
Total Delay	62.4	50.3	9.5		52.6	35.7	8.5	40.7	63.1	4.6		43.0
LOS	E	D	A		D	D	A	D	E	A		D
Approach Delay		45.3				33.2			54.4			
Approach LOS		D				C			D			
Queue Length 50th (ft)	111	181	6		85	97	0	33	~421	0		58
Queue Length 95th (ft)	#223	#263	65		#161	132	54	58	#553	44		93
Internal Link Dist (ft)		707				621			575			
Turn Bay Length (ft)	200		130		240		140	120		250		270
Base Capacity (vph)	259	962	465		259	962	441	417	1238	675		417
Starvation Cap Reductn	0	0	0		0	0	0	0	0	0		0
Spillback Cap Reductn	0	0	0		0	0	0	0	0	0		0
Storage Cap Reductn	0	0	0		0	0	0	0	0	0		0
Reduced v/c Ratio	0.77	0.91	0.47		0.61	0.53	0.40	0.29	1.03	0.28		0.50

Intersection Summary

Area Type:	Other
Cycle Length:	90
Actuated Cycle Length:	87.3
Control Type:	Actuated-Uncoordinated
Maximum v/c Ratio:	1.03
Intersection Signal Delay:	41.7
Intersection LOS:	D

Lanes, Volumes, Timings  
 1: Harbor Boulevard & Orangethorpe Avenue

05/23/2021



Lane Group	SBT	SBR
Lane Configurations	↑↑↑	
Traffic Volume (vph)	1452	125
Future Volume (vph)	1452	125
Ideal Flow (vphpl)	1900	1900
Storage Length (ft)		160
Storage Lanes		0
Taper Length (ft)		
Satd. Flow (prot)	5024	0
Flt Permitted		
Satd. Flow (perm)	5024	0
Right Turn on Red		Yes
Satd. Flow (RTOR)	17	
Link Speed (mph)	40	
Link Distance (ft)	935	
Travel Time (s)	15.9	
Peak Hour Factor	0.92	0.92
Shared Lane Traffic (%)		
Lane Group Flow (vph)	1714	0
Turn Type	NA	
Protected Phases	6	
Permitted Phases		
Total Split (s)	35.0	
Total Lost Time (s)	4.5	
Act Effct Green (s)	34.5	
Actuated g/C Ratio	0.40	
v/c Ratio	0.86	
Control Delay	31.3	
Queue Delay	0.0	
Total Delay	31.3	
LOS	C	
Approach Delay	32.6	
Approach LOS	C	
Queue Length 50th (ft)	331	
Queue Length 95th (ft)	#465	
Internal Link Dist (ft)	855	
Turn Bay Length (ft)		
Base Capacity (vph)	1994	
Starvation Cap Reductn	0	
Spillback Cap Reductn	0	
Storage Cap Reductn	0	
Reduced v/c Ratio	0.86	
Intersection Summary		

Lanes, Volumes, Timings  
 1: Harbor Boulevard & Orangethorpe Avenue

05/23/2021

Intersection Capacity Utilization 77.5%      ICU Level of Service D

Analysis Period (min) 15









~ Volume exceeds capacity, queue is theoretically infinite.

Queue shown is maximum after two cycles.

# 95th percentile volume exceeds capacity, queue may be longer.

Queue shown is maximum after two cycles.

Splits and Phases: 1: Harbor Boulevard & Orangethorpe Avenue

 Ø1	 Ø2	 Ø3	 Ø4
 Ø5	 Ø6	 Ø7	 Ø8
16 s	35 s	18 s	21 s
16 s	35 s	18 s	21 s

Lanes, Volumes, Timings  
2: Pomona Avenue & Orangethorpe Avenue

05/23/2021



Lane Group	EBU	EBL	EBT	EBR	WBU	WBL	WBT	WBR	NBL	NBT	NBR	SBL
Lane Configurations												
Traffic Volume (vph)	2	96	1146	50	20	23	684	86	55	18	27	73
Future Volume (vph)	2	96	1146	50	20	23	684	86	55	18	27	73
Ideal Flow (vphpl)	1800	1800	1900	1900	1800	1800	1900	1900	1800	1900	1900	1800
Storage Length (ft)		140		0		150		70	95		0	70
Storage Lanes		1		0		1		1	1		0	1
Taper Length (ft)		60				70			30			60
Satd. Flow (prot)	0	1676	5055	0	0	1676	3539	1583	1676	1697	0	1676
Flt Permitted		0.370				0.194			0.714			0.725
Satd. Flow (perm)	0	653	5055	0	0	342	3539	1583	1260	1697	0	1279
Right Turn on Red				Yes				Yes			Yes	
Satd. Flow (RTOR)			28					93		29		
Link Speed (mph)			40				40			25		
Link Distance (ft)			701				647			214		
Travel Time (s)			11.9				11.0			5.8		
Peak Hour Factor	0.92	0.92	0.92	0.92	0.92	0.92	0.92	0.92	0.92	0.92	0.92	0.92
Shared Lane Traffic (%)												
Lane Group Flow (vph)	0	106	1300	0	0	47	743	93	60	49	0	79
Turn Type	Perm	Perm	NA		Perm	Perm	NA	Perm	Perm	NA		Perm
Protected Phases			4				8			2		
Permitted Phases	4	4			8	8		8	2			6
Total Split (s)	33.0	33.0	33.0		33.0	33.0	33.0	33.0	12.0	12.0		12.0
Total Lost Time (s)		4.5	4.5				4.5	4.5	4.5	4.5		4.5
Act Effct Green (s)		26.1	26.1				26.1	26.1	26.1	7.0	7.0	7.0
Actuated g/C Ratio		0.68	0.68				0.68	0.68	0.68	0.18	0.18	0.18
v/c Ratio		0.24	0.38				0.20	0.31	0.08	0.26	0.15	0.34
Control Delay		5.7	4.2				6.5	4.2	1.2	18.3	10.5	19.7
Queue Delay		0.0	0.0				0.0	0.0	0.0	0.0	0.0	0.0
Total Delay		5.7	4.2				6.5	4.2	1.2	18.3	10.5	19.7
LOS		A	A				A	A	A	B	B	B
Approach Delay			4.3				4.0			14.8		
Approach LOS			A				A			B		
Queue Length 50th (ft)		9	45				4	35	0	10	3	13
Queue Length 95th (ft)		26	64				16	55	9	39	25	49
Internal Link Dist (ft)			621					567		134		
Turn Bay Length (ft)		140					150		70	95		70
Base Capacity (vph)		494	3833				259	2679	1220	251	361	254
Starvation Cap Reductn		0	0				0	0	0	0	0	0
Spillback Cap Reductn		0	0				0	0	0	0	0	0
Storage Cap Reductn		0	0				0	0	0	0	0	0
Reduced v/c Ratio		0.21	0.34				0.18	0.28	0.08	0.24	0.14	0.31

Intersection Summary

Area Type: Other  
 Cycle Length: 45  
 Actuated Cycle Length: 38.5  
 Control Type: Actuated-Uncoordinated  
 Maximum v/c Ratio: 0.38  
 Intersection Signal Delay: 5.2 Intersection LOS: A



Lanes, Volumes, Timings  
 2: Pomona Avenue & Orangethorpe Avenue

05/23/2021



Lane Group	SBT	SBR
Lane Configurations	7	65
Traffic Volume (vph)	7	65
Future Volume (vph)	7	65
Ideal Flow (vphpl)	1900	1900
Storage Length (ft)		0
Storage Lanes		0
Taper Length (ft)		
Satd. Flow (prot)	1611	0
Flt Permitted		
Satd. Flow (perm)	1611	0
Right Turn on Red		Yes
Satd. Flow (RTOR)	71	
Link Speed (mph)	25	
Link Distance (ft)	398	
Travel Time (s)	10.9	
Peak Hour Factor	0.92	0.92
Shared Lane Traffic (%)		
Lane Group Flow (vph)	79	0
Turn Type	NA	
Protected Phases	6	
Permitted Phases		
Total Split (s)	12.0	
Total Lost Time (s)	4.5	
Act Effct Green (s)	7.0	
Actuated g/C Ratio	0.18	
v/c Ratio	0.23	
Control Delay	7.8	
Queue Delay	0.0	
Total Delay	7.8	
LOS	A	
Approach Delay	13.8	
Approach LOS	B	
Queue Length 50th (ft)	1	
Queue Length 95th (ft)	28	
Internal Link Dist (ft)	318	
Turn Bay Length (ft)		
Base Capacity (vph)	377	
Starvation Cap Reductn	0	
Spillback Cap Reductn	0	
Storage Cap Reductn	0	
Reduced v/c Ratio	0.21	
Intersection Summary		

Lanes, Volumes, Timings  
2: Pomona Avenue & Orangethorpe Avenue

05/23/2021

Intersection Capacity Utilization 49.6%      ICU Level of Service A  
Analysis Period (min) 15

Splits and Phases: 2: Pomona Avenue & Orangethorpe Avenue



Lanes, Volumes, Timings  
3: Lemon Street & Orangethorpe Avenue

05/23/2021



Lane Group	EBU	EBL	EBT	EBR	WBL	WBT	WBR	NBL	NBT	NBR	SBL	SBT
Lane Configurations		↔	↔↔↔		↔↔	↔↔		↔	↔↔	↔	↔	↔↔
Traffic Volume (vph)	2	82	1000	209	146	558	107	239	732	219	198	797
Future Volume (vph)	2	82	1000	209	146	558	107	239	732	219	198	797
Ideal Flow (vphpl)	1800	1800	1900	1900	1750	1900	1900	1800	1900	1900	1800	1900
Storage Length (ft)		140		0	170		0	200		130	145	
Storage Lanes		1		0	2		0	1		1	1	
Taper Length (ft)		115			120			90			105	
Satd. Flow (prot)	0	1676	4953	0	3162	3454	0	1676	3539	1583	1676	3539
Flt Permitted		0.950			0.950			0.163			0.167	
Satd. Flow (perm)	0	1676	4953	0	3162	3454	0	288	3539	1583	295	3539
Right Turn on Red				Yes			Yes			Yes		
Satd. Flow (RTOR)			48			24				194		
Link Speed (mph)			40			40			40			40
Link Distance (ft)			647			477			670			291
Travel Time (s)			11.0			8.1			11.4			5.0
Peak Hour Factor	0.92	0.92	0.92	0.92	0.92	0.92	0.92	0.92	0.92	0.92	0.92	0.92
Shared Lane Traffic (%)												
Lane Group Flow (vph)	0	91	1314	0	159	723	0	260	796	238	215	866
Turn Type	Prot	Prot	NA		Prot	NA		pm+pt	NA	Perm	pm+pt	NA
Protected Phases	7	7	4		3	8		5	2		1	6
Permitted Phases								2		2	6	
Total Split (s)	17.0	17.0	28.0		17.0	28.0		16.0	29.0	29.0	16.0	29.0
Total Lost Time (s)		4.5	4.5		4.5	4.5		4.5	4.5	4.5	4.5	4.5
Act Effct Green (s)		9.7	23.8		9.6	26.0		36.1	24.5	24.5	34.7	23.9
Actuated g/C Ratio		0.11	0.27		0.11	0.30		0.42	0.28	0.28	0.40	0.28
v/c Ratio		0.49	0.95		0.45	0.69		0.86	0.80	0.41	0.74	0.89
Control Delay		45.4	45.2		40.5	31.5		47.6	36.4	8.9	34.3	43.4
Queue Delay		0.0	0.0		0.0	0.0		0.0	0.0	0.0	0.0	0.0
Total Delay		45.4	45.2		40.5	31.5		47.6	36.4	8.9	34.3	43.4
LOS		D	D		D	C		D	D	A	C	D
Approach Delay			45.2			33.2			33.6			38.7
Approach LOS			D			C			C			D
Queue Length 50th (ft)		48	252		43	186		91	214	18	70	238
Queue Length 95th (ft)		95	#369		72	262		#239	#302	78	#170	#360
Internal Link Dist (ft)			567			397			590			211
Turn Bay Length (ft)		140			170			200		130	145	
Base Capacity (vph)		241	1390		455	1050		303	1003	587	303	999
Starvation Cap Reductn		0	0		0	0		0	0	0	0	0
Spillback Cap Reductn		0	0		0	0		0	0	0	0	0
Storage Cap Reductn		0	0		0	0		0	0	0	0	0
Reduced v/c Ratio		0.38	0.95		0.35	0.69		0.86	0.79	0.41	0.71	0.87

**Intersection Summary**  
 Area Type: Other  
 Cycle Length: 90  
 Actuated Cycle Length: 86.8  
 Control Type: Actuated-Uncoordinated  
 Maximum v/c Ratio: 0.95  
 Intersection Signal Delay: 38.2      Intersection LOS: D

Lanes, Volumes, Timings  
 3: Lemon Street & Orangethorpe Avenue

05/23/2021

Lane Group	SBR
Lane Configurations	
Traffic Volume (vph)	79
Future Volume (vph)	79
Ideal Flow (vphpl)	1900
Storage Length (ft)	175
Storage Lanes	1
Taper Length (ft)	
Satd. Flow (prot)	1583
Flt Permitted	
Satd. Flow (perm)	1583
Right Turn on Red	Yes
Satd. Flow (RTOR)	127
Link Speed (mph)	
Link Distance (ft)	
Travel Time (s)	
Peak Hour Factor	0.92
Shared Lane Traffic (%)	
Lane Group Flow (vph)	86
Turn Type	Perm
Protected Phases	
Permitted Phases	6
Total Split (s)	29.0
Total Lost Time (s)	4.5
Act Effct Green (s)	23.9
Actuated g/C Ratio	0.28
v/c Ratio	0.16
Control Delay	2.6
Queue Delay	0.0
Total Delay	2.6
LOS	A
Approach Delay	
Approach LOS	
Queue Length 50th (ft)	0
Queue Length 95th (ft)	16
Internal Link Dist (ft)	
Turn Bay Length (ft)	175
Base Capacity (vph)	538
Starvation Cap Reductn	0
Spillback Cap Reductn	0
Storage Cap Reductn	0
Reduced v/c Ratio	0.16
<b>Intersection Summary</b>	



Lanes, Volumes, Timings  
 3: Lemon Street & Orangethorpe Avenue

05/23/2021

Intersection Capacity Utilization 79.5% ICU Level of Service D

Analysis Period (min) 15

# 95th percentile volume exceeds capacity, queue may be longer.





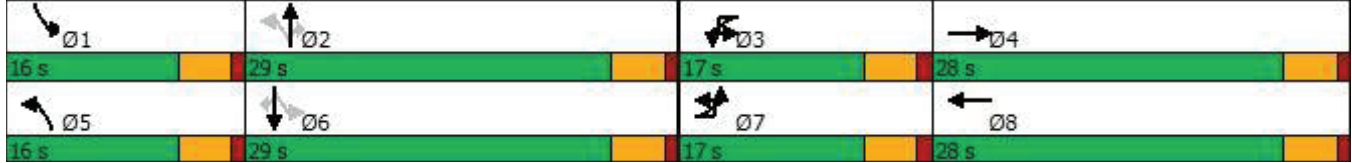















Queue shown is maximum after two cycles.

Splits and Phases: 3: Lemon Street & Orangethorpe Avenue



Lanes, Volumes, Timings  
4: Lemon Street & South Project Access

05/23/2021

												
Lane Group	EBL	EBT	EBR	WBL	WBT	WBR	NBL	NBT	NBR	SBL	SBT	SBR
Lane Configurations												
Traffic Volume (vph)	2	0	44	0	0	4	4	916	4	0	1048	26
Future Volume (vph)	2	0	44	0	0	4	4	916	4	0	1048	26
Ideal Flow (vphpl)	1900	1900	1900	1900	1900	1900	1800	1900	1900	1800	1900	1900
Storage Length (ft)	0		0	0		0	20		0	50		0
Storage Lanes	0		0	0		1	1		0	1		0
Taper Length (ft)	25			25			25			25		
Satd. Flow (prot)	0	1617	0	0	1863	1583	1676	3536	0	1765	3525	0
Flt Permitted		0.998					0.950					
Satd. Flow (perm)	0	1617	0	0	1863	1583	1676	3536	0	1765	3525	0
Link Speed (mph)		25			30			40			40	
Link Distance (ft)		267			71			291			254	
Travel Time (s)		7.3			1.6			5.0			4.3	
Peak Hour Factor	0.92	0.92	0.92	0.92	0.92	0.92	0.92	0.92	0.92	0.92	0.92	0.92
Shared Lane Traffic (%)												
Lane Group Flow (vph)	0	50	0	0	0	4	4	1000	0	0	1167	0
Sign Control		Stop			Stop			Free			Free	
<b>Intersection Summary</b>												
Area Type:	Other											
Control Type:	Unsignalized											
Intersection Capacity Utilization	42.1%			ICU Level of Service A								
Analysis Period (min)	15											

HCM 6th TWSC  
4: Lemon Street & South Project Access

05/23/2021

Intersection												
Int Delay, s/veh	0.4											
Movement	EBL	EBT	EBR	WBL	WBT	WBR	NBL	NBT	NBR	SBL	SBT	SBR
Lane Configurations		↕			↕	↕	↕	↕		↕	↕	
Traffic Vol, veh/h	2	0	44	0	0	4	4	916	4	0	1048	26
Future Vol, veh/h	2	0	44	0	0	4	4	916	4	0	1048	26
Conflicting Peds, #/hr	0	0	0	0	0	0	0	0	0	0	0	0
Sign Control	Stop	Stop	Stop	Stop	Stop	Stop	Free	Free	Free	Free	Free	Free
RT Channelized	-	-	None	-	-	None	-	-	None	-	-	None
Storage Length	-	-	-	-	-	0	20	-	-	50	-	-
Veh in Median Storage, #	0	-	-	0	-	-	0	-	-	0	-	-
Grade, %	-	0	-	-	0	-	-	0	-	-	0	-
Peak Hour Factor	92	92	92	92	92	92	92	92	92	92	92	92
Heavy Vehicles, %	2	2	2	2	2	2	2	2	2	2	2	2
Mvmt Flow	2	0	48	0	0	4	4	996	4	0	1139	28

Major/Minor	Minor2	Minor1		Major1		Major2						
Conflicting Flow All	1659	2161	584	1576	2173	500	1167	0	0	1000	0	0
Stage 1	1153	1153	-	1006	1006	-	-	-	-	-	-	-
Stage 2	506	1008	-	570	1167	-	-	-	-	-	-	-
Critical Hdwy	7.54	6.54	6.94	7.54	6.54	6.94	4.14	-	-	4.14	-	-
Critical Hdwy Stg 1	6.54	5.54	-	6.54	5.54	-	-	-	-	-	-	-
Critical Hdwy Stg 2	6.54	5.54	-	6.54	5.54	-	-	-	-	-	-	-
Follow-up Hdwy	3.52	4.02	3.32	3.52	4.02	3.32	2.22	-	-	2.22	-	-
Pot Cap-1 Maneuver	64	47	455	74	46	516	594	-	-	688	-	-
Stage 1	210	270	-	258	317	-	-	-	-	-	-	-
Stage 2	517	316	-	474	266	-	-	-	-	-	-	-
Platoon blocked, %								-	-	-	-	-
Mov Cap-1 Maneuver	63	47	455	66	46	516	594	-	-	688	-	-
Mov Cap-2 Maneuver	63	47	-	66	46	-	-	-	-	-	-	-
Stage 1	209	270	-	256	315	-	-	-	-	-	-	-
Stage 2	509	314	-	424	266	-	-	-	-	-	-	-

Approach	EB	WB	NB	SB
HCM Control Delay, s	16.7	12	0	0
HCM LOS	C	B		

Minor Lane/Major Mvmt	NBL	NBT	NBR	EBLn	WBLn	WBLn2	SBL	SBT	SBR
Capacity (veh/h)	594	-	-	358	-	516	688	-	-
HCM Lane V/C Ratio	0.007	-	-	0.14	-	0.008	-	-	-
HCM Control Delay (s)	11.1	-	-	16.7	0	12	0	-	-
HCM Lane LOS	B	-	-	C	A	B	A	-	-
HCM 95th %tile Q(veh)	0	-	-	0.5	-	0	0	-	-

Lanes, Volumes, Timings

5: Lemon Street & North Project Access/Liberty Avenue

05/23/2021



Lane Group	EBL	EBT	EBR	WBL	WBT	WBR	NBL	NBT	NBR	SBL	SBT	SBR
Lane Configurations		↔	↔		↔		↔	↔		↔	↔	
Traffic Volume (vph)	18	0	58	51	2	12	23	776	93	28	965	18
Future Volume (vph)	18	0	58	51	2	12	23	776	93	28	965	18
Ideal Flow (vphpl)	1900	1900	1900	1900	1900	1900	1800	1900	1900	1800	1900	1900
Storage Length (ft)	0		0	0		0	50		0	50		0
Storage Lanes	0		1	0		0	1		0	1		0
Taper Length (ft)	25			25			25			25		
Satd. Flow (prot)	0	1770	1583	0	1747	0	1676	3483	0	1676	3529	0
Flt Permitted		0.950			0.962		0.950			0.950		
Satd. Flow (perm)	0	1770	1583	0	1747	0	1676	3483	0	1676	3529	0
Link Speed (mph)		30			25			40			40	
Link Distance (ft)		333			454			254			394	
Travel Time (s)		7.6			12.4			4.3			6.7	
Peak Hour Factor	0.92	0.92	0.92	0.92	0.92	0.92	0.92	0.92	0.92	0.92	0.92	0.92
Shared Lane Traffic (%)												
Lane Group Flow (vph)	0	20	63	0	70	0	25	944	0	30	1069	0
Sign Control		Stop			Stop			Free			Free	

Intersection Summary

Area Type:	Other
Control Type:	Unsignalized
Intersection Capacity Utilization	44.5%
	ICU Level of Service A
Analysis Period (min)	15



HCM 6th TWSC  
 5: Lemon Street & North Project Access/Liberty Avenue

05/23/2021

Intersection												
Int Delay, s/veh	6.8											
Movement	EBL	EBT	EBR	WBL	WBT	WBR	NBL	NBT	NBR	SBL	SBT	SBR
Lane Configurations		↕	↗		↕	↗	↕	↗		↕	↗	
Traffic Vol, veh/h	18	0	58	51	2	12	23	776	93	28	965	18
Future Vol, veh/h	18	0	58	51	2	12	23	776	93	28	965	18
Conflicting Peds, #/hr	0	0	0	0	0	0	0	0	0	0	0	0
Sign Control	Stop	Stop	Stop	Stop	Stop	Stop	Free	Free	Free	Free	Free	Free
RT Channelized	-	-	None	-	-	None	-	-	None	-	-	None
Storage Length	-	-	0	-	-	-	50	-	-	50	-	-
Veh in Median Storage, #	0	-	-	0	-	-	0	-	-	0	-	-
Grade, %	-	0	-	-	0	-	-	0	-	-	0	-
Peak Hour Factor	92	92	92	92	92	92	92	92	92	92	92	92
Heavy Vehicles, %	2	2	2	2	2	2	2	2	2	2	2	2
Mvmt Flow	20	0	63	55	2	13	25	843	101	30	1049	20

Major/Minor	Minor2	Minor1		Major1		Major2						
Conflicting Flow All	1592	2113	535	1529	2073	472	1069	0	0	944	0	0
Stage 1	1119	1119	-	944	944	-	-	-	-	-	-	-
Stage 2	473	994	-	585	1129	-	-	-	-	-	-	-
Critical Hdwy	7.54	6.54	6.94	7.54	6.54	6.94	4.14	-	-	4.14	-	-
Critical Hdwy Stg 1	6.54	5.54	-	6.54	5.54	-	-	-	-	-	-	-
Critical Hdwy Stg 2	6.54	5.54	-	6.54	5.54	-	-	-	-	-	-	-
Follow-up Hdwy	3.52	4.02	3.32	3.52	4.02	3.32	2.22	-	-	2.22	-	-
Pot Cap-1 Maneuver	72	50	490	80	53	538	648	-	-	722	-	-
Stage 1	220	280	-	282	339	-	-	-	-	-	-	-
Stage 2	541	321	-	464	277	-	-	-	-	-	-	-
Platoon blocked, %								-	-	-	-	-
Mov Cap-1 Maneuver	64	46	490	66	49	538	648	-	-	722	-	-
Mov Cap-2 Maneuver	64	46	-	66	49	-	-	-	-	-	-	-
Stage 1	211	268	-	271	326	-	-	-	-	-	-	-
Stage 2	504	308	-	388	265	-	-	-	-	-	-	-

Approach	EB	WB	NB	SB
HCM Control Delay, s	30.2	168.7	0.3	0.3
HCM LOS	D	F		

Minor Lane/Major Mvmt	NBL	NBT	NBR	EBLn	EBLn1	WBLn	SBL	SBT	SBR
Capacity (veh/h)	648	-	-	64	490	78	722	-	-
HCM Lane V/C Ratio	0.039	-	-	0.306	0.129	0.906	0.042	-	-
HCM Control Delay (s)	10.8	-	-	84.3	13.4	168.7	10.2	-	-
HCM Lane LOS	B	-	-	F	B	F	B	-	-
HCM 95th %tile Q(veh)	0.1	-	-	1.1	0.4	4.7	0.1	-	-

Lanes, Volumes, Timings  
1: Harbor Boulevard & Orangethorpe Avenue

05/23/2021



Lane Group	EBU	EBL	EBT	EBR	WBU	WBL	WBT	WBR	NBU	NBL	NBT	NBR
Lane Configurations		↔	↔↔↔	↗		↔	↔↔↔	↗		↔↔	↔↔	↗
Traffic Volume (vph)	2	235	780	179	15	216	935	194	1	232	1183	222
Future Volume (vph)	2	235	780	179	15	216	935	194	1	232	1183	222
Ideal Flow (vphpl)	1800	1800	1900	1900	1800	1800	1900	1900	1750	1750	1900	1900
Storage Length (ft)		200		130		240		140		120		250
Storage Lanes		1		1		1		1		2		0
Taper Length (ft)		90				60				90		
Satd. Flow (prot)	0	1676	5085	1583	0	1676	5085	1583	0	3162	3539	1583
Flt Permitted		0.950				0.950				0.950		
Satd. Flow (perm)	0	1676	5085	1583	0	1676	5085	1583	0	3162	3539	1583
Right Turn on Red				Yes				Yes				Yes
Satd. Flow (RTOR)				174				170				219
Link Speed (mph)			40				40				40	
Link Distance (ft)			787				701				655	
Travel Time (s)			13.4				11.9				11.2	
Peak Hour Factor	0.92	0.92	0.92	0.92	0.92	0.92	0.92	0.92	0.92	0.92	0.92	0.92
Shared Lane Traffic (%)												
Lane Group Flow (vph)	0	257	848	195	0	251	1016	211	0	253	1286	241
Turn Type	Prot	Prot	NA	Perm	Prot	Prot	NA	Perm	Prot	Prot	NA	Perm
Protected Phases	7	7	4		3	3	8		5	5	2	
Permitted Phases				4				8				2
Total Split (s)	22.0	22.0	24.0	24.0	23.0	23.0	25.0	25.0	21.0	21.0	40.0	40.0
Total Lost Time (s)		4.5	4.5	4.5			4.5	4.5		4.5	4.5	4.5
Act Effct Green (s)		17.0	20.0	20.0			17.5	20.5		13.1	35.5	35.5
Actuated g/C Ratio		0.17	0.20	0.20			0.18	0.21		0.13	0.36	0.36
v/c Ratio		0.90	0.83	0.43			0.85	0.97		0.61	1.02	0.34
Control Delay		74.4	46.6	10.6			66.2	61.5		47.0	62.9	5.7
Queue Delay		0.0	0.0	0.0			0.0	0.0		0.0	0.0	0.0
Total Delay		74.4	46.6	10.6			66.2	61.5		47.0	62.9	5.7
LOS		E	D	B			E	E		D	E	A
Approach Delay			46.7				55.3				52.9	
Approach LOS			D				E				D	
Queue Length 50th (ft)		161	193	11			155	237		79	~462	9
Queue Length 95th (ft)		#303	#257	72			#281	#330		115	#595	60
Internal Link Dist (ft)			707				621				575	
Turn Bay Length (ft)		200		130			240			120		250
Base Capacity (vph)		294	1022	457			312	1047		524	1262	705
Starvation Cap Reductn		0	0	0			0	0		0	0	0
Spillback Cap Reductn		0	0	0			0	0		0	0	0
Storage Cap Reductn		0	0	0			0	0		0	0	0
Reduced v/c Ratio		0.87	0.83	0.43			0.80	0.97		0.48	1.02	0.34

Intersection Summary

Area Type:	Other
Cycle Length:	100
Actuated Cycle Length:	99.5
Control Type:	Actuated-Uncoordinated
Maximum v/c Ratio:	1.02
Intersection Signal Delay:	51.4
Intersection LOS:	D

Lanes, Volumes, Timings  
 1: Harbor Boulevard & Orangethorpe Avenue

05/23/2021



Lane Group	SBU	SBL	SBT	SBR
Lane Configurations				
Traffic Volume (vph)	13	197	1154	208
Future Volume (vph)	13	197	1154	208
Ideal Flow (vphpl)	1750	1750	1900	1900
Storage Length (ft)		270		160
Storage Lanes		2		0
Taper Length (ft)		100		
Satd. Flow (prot)	0	3162	4968	0
Flt Permitted		0.950		
Satd. Flow (perm)	0	3162	4968	0
Right Turn on Red				Yes
Satd. Flow (RTOR)			36	
Link Speed (mph)			40	
Link Distance (ft)			935	
Travel Time (s)			15.9	
Peak Hour Factor	0.92	0.92	0.92	0.92
Shared Lane Traffic (%)				
Lane Group Flow (vph)	0	228	1480	0
Turn Type	Prot	Prot	NA	
Protected Phases	1	1	6	
Permitted Phases				
Total Split (s)	13.0	13.0	32.0	
Total Lost Time (s)		4.5	4.5	
Act Effct Green (s)		8.5	30.9	
Actuated g/C Ratio		0.09	0.31	
v/c Ratio		0.85	0.94	
Control Delay		72.7	46.8	
Queue Delay		0.0	0.0	
Total Delay		72.7	46.8	
LOS		E	D	
Approach Delay			50.2	
Approach LOS			D	
Queue Length 50th (ft)		75	330	
Queue Length 95th (ft)		#140	#473	
Internal Link Dist (ft)			855	
Turn Bay Length (ft)		270		
Base Capacity (vph)		269	1568	
Starvation Cap Reductn		0	0	
Spillback Cap Reductn		0	0	
Storage Cap Reductn		0	0	
Reduced v/c Ratio		0.85	0.94	
<b>Intersection Summary</b>				

# Lanes, Volumes, Timings

## 1: Harbor Boulevard & Orangethorpe Avenue

05/23/2021

Intersection Capacity Utilization 86.1%      ICU Level of Service E

Analysis Period (min) 15

~ Volume exceeds capacity, queue is theoretically infinite.

Queue shown is maximum after two cycles.

# 95th percentile volume exceeds capacity, queue may be longer.

Queue shown is maximum after two cycles.

Splits and Phases: 1: Harbor Boulevard & Orangethorpe Avenue

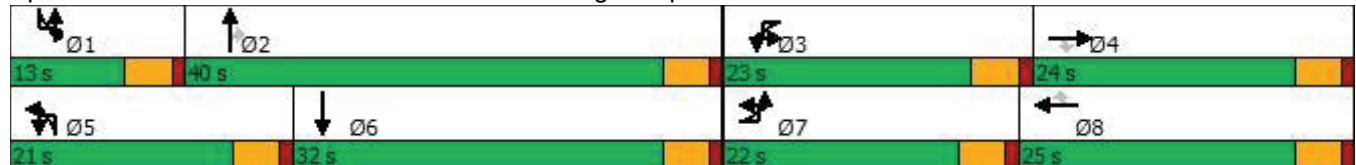





Lanes, Volumes, Timings  
 2: Pomona Avenue & Orangethorpe Avenue

05/23/2021



Lane Group	SBT	SBR
Lane Configurations		
Traffic Volume (vph)	35	102
Future Volume (vph)	35	102
Ideal Flow (vphpl)	1900	1900
Storage Length (ft)		0
Storage Lanes		0
Taper Length (ft)		
Satd. Flow (prot)	1654	0
Flt Permitted		
Satd. Flow (perm)	1654	0
Right Turn on Red		Yes
Satd. Flow (RTOR)	111	
Link Speed (mph)	25	
Link Distance (ft)	398	
Travel Time (s)	10.9	
Peak Hour Factor	0.92	0.92
Shared Lane Traffic (%)		
Lane Group Flow (vph)	149	0
Turn Type	NA	
Protected Phases	6	
Permitted Phases		
Total Split (s)	15.0	
Total Lost Time (s)	4.5	
Act Effct Green (s)	9.5	
Actuated g/C Ratio	0.22	
v/c Ratio	0.33	
Control Delay	9.0	
Queue Delay	0.0	
Total Delay	9.0	
LOS	A	
Approach Delay	19.9	
Approach LOS	B	
Queue Length 50th (ft)	9	
Queue Length 95th (ft)	46	
Internal Link Dist (ft)	318	
Turn Bay Length (ft)		
Base Capacity (vph)	510	
Starvation Cap Reductn	0	
Spillback Cap Reductn	0	
Storage Cap Reductn	0	
Reduced v/c Ratio	0.29	
Intersection Summary		

Lanes, Volumes, Timings  
2: Pomona Avenue & Orangethorpe Avenue

05/23/2021

Intersection Capacity Utilization 65.4%      ICU Level of Service C

Analysis Period (min) 15

# 95th percentile volume exceeds capacity, queue may be longer.

Queue shown is maximum after two cycles.

Splits and Phases: 2: Pomona Avenue & Orangethorpe Avenue



Lanes, Volumes, Timings  
3: Lemon Street & Orangethorpe Avenue

05/23/2021



Lane Group	EBU	EBL	EBT	EBR	WBU	WBL	WBT	WBR	NBL	NBT	NBR	SBL
Lane Configurations		3	↑↑↑			3	↑↑		↑	↑↑	↑	↑
Traffic Volume (vph)	2	188	837	212	4	261	846	173	316	918	108	175
Future Volume (vph)	2	188	837	212	4	261	846	173	316	918	108	175
Ideal Flow (vphpl)	1800	1800	1900	1900	1750	1750	1900	1900	1800	1900	1900	1800
Storage Length (ft)		140		0		170		0	200		130	145
Storage Lanes		1		0		2		0	1		1	1
Taper Length (ft)		115				120			90			105
Satd. Flow (prot)	0	1676	4933	0	0	3162	3451	0	1676	3539	1583	1676
Flt Permitted		0.950				0.950			0.143			0.170
Satd. Flow (perm)	0	1676	4933	0	0	3162	3451	0	252	3539	1583	300
Right Turn on Red				Yes				Yes			Yes	
Satd. Flow (RTOR)			62				25				115	
Link Speed (mph)			40				40			40		
Link Distance (ft)			647				859			670		
Travel Time (s)			11.0				14.6			11.4		
Peak Hour Factor	0.92	0.92	0.92	0.92	0.92	0.92	0.92	0.92	0.92	0.92	0.92	0.92
Shared Lane Traffic (%)												
Lane Group Flow (vph)	0	206	1140	0	0	288	1108	0	343	998	117	190
Turn Type	Prot	Prot	NA		Prot	Prot	NA		pm+pt	NA	Perm	pm+pt
Protected Phases	7	7	4		3	3	8		5	2		1
Permitted Phases									2		2	6
Total Split (s)	17.0	17.0	33.0		19.0	19.0	35.0		20.0	35.0	35.0	13.0
Total Lost Time (s)		4.5	4.5				4.5	4.5	4.5	4.5	4.5	4.5
Act Effct Green (s)		12.5	29.7				13.3	30.5	43.5	30.5	30.5	32.0
Actuated g/C Ratio		0.12	0.30				0.13	0.30	0.44	0.30	0.30	0.32
v/c Ratio		0.99	0.75				0.69	1.04	1.04	0.92	0.21	0.90
Control Delay		104.2	34.1				50.3	71.7	87.9	48.8	6.2	64.4
Queue Delay		0.0	0.0				0.0	0.0	0.0	0.0	0.0	0.0
Total Delay		104.2	34.1				50.3	71.7	87.9	48.8	6.2	64.4
LOS		F	C				D	E	F	D	A	E
Approach Delay			44.8				67.3			54.6		
Approach LOS			D				E			D		
Queue Length 50th (ft)		133	231				90	~396	~189	322	1	75
Queue Length 95th (ft)		#278	286				134	#528	#366	#448	41	#197
Internal Link Dist (ft)			567					779		590		
Turn Bay Length (ft)		140					170		200		130	145
Base Capacity (vph)		209	1510				458	1069	330	1079	562	212
Starvation Cap Reductn		0	0				0	0	0	0	0	0
Spillback Cap Reductn		0	0				0	0	0	0	0	0
Storage Cap Reductn		0	0				0	0	0	0	0	0
Reduced v/c Ratio		0.99	0.75				0.63	1.04	1.04	0.92	0.21	0.90

Intersection Summary

Area Type:	Other
Cycle Length:	100
Actuated Cycle Length:	100
Control Type:	Actuated-Uncoordinated
Maximum v/c Ratio:	1.04
Intersection Signal Delay:	57.0
Intersection LOS:	E



Lanes, Volumes, Timings  
 3: Lemon Street & Orangethorpe Avenue

05/23/2021



Lane Group	SBT	SBR
Lane Configurations	↑↑	↑
Traffic Volume (vph)	767	139
Future Volume (vph)	767	139
Ideal Flow (vphpl)	1900	1900
Storage Length (ft)		175
Storage Lanes		1
Taper Length (ft)		
Satd. Flow (prot)	3539	1583
Flt Permitted		
Satd. Flow (perm)	3539	1583
Right Turn on Red		Yes
Satd. Flow (RTOR)		164
Link Speed (mph)	40	
Link Distance (ft)	291	
Travel Time (s)	5.0	
Peak Hour Factor	0.92	0.92
Shared Lane Traffic (%)		
Lane Group Flow (vph)	834	151
Turn Type	NA	Perm
Protected Phases	6	
Permitted Phases		6
Total Split (s)	28.0	28.0
Total Lost Time (s)	4.5	4.5
Act Effct Green (s)	23.5	23.5
Actuated g/C Ratio	0.24	0.24
v/c Ratio	1.00	0.30
Control Delay	71.2	6.0
Queue Delay	0.0	0.0
Total Delay	71.2	6.0
LOS	E	A
Approach Delay	61.7	
Approach LOS	E	
Queue Length 50th (ft)	~282	0
Queue Length 95th (ft)	#415	42
Internal Link Dist (ft)	211	
Turn Bay Length (ft)		175
Base Capacity (vph)	831	497
Starvation Cap Reductn	0	0
Spillback Cap Reductn	0	0
Storage Cap Reductn	0	0
Reduced v/c Ratio	1.00	0.30
<b>Intersection Summary</b>		

Lanes, Volumes, Timings  
 3: Lemon Street & Orangethorpe Avenue

05/23/2021

Intersection Capacity Utilization 94.7% ICU Level of Service F

Analysis Period (min) 15

~ Volume exceeds capacity, queue is theoretically infinite.

Queue shown is maximum after two cycles.

# 95th percentile volume exceeds capacity, queue may be longer.





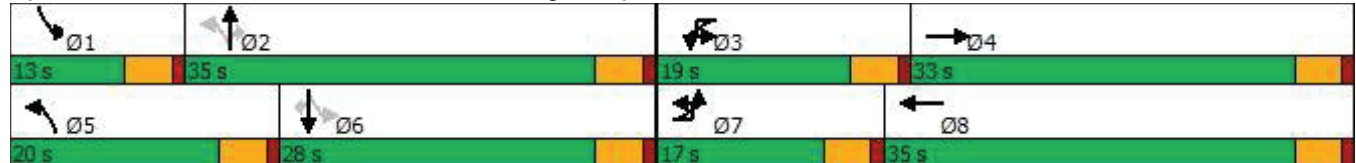















Queue shown is maximum after two cycles.

Splits and Phases: 3: Lemon Street & Orangethorpe Avenue



Lanes, Volumes, Timings  
 4: Lemon Street & South Project Access

05/23/2021

												
Lane Group	EBL	EBT	EBR	WBL	WBT	WBR	NBL	NBT	NBR	SBL	SBT	SBR
Lane Configurations												
Traffic Volume (vph)	11	2	72	25	1	25	13	1229	40	16	982	19
Future Volume (vph)	11	2	72	25	1	25	13	1229	40	16	982	19
Ideal Flow (vphpl)	1900	1900	1900	1900	1900	1900	1800	1900	1900	1800	1900	1900
Storage Length (ft)	0		0	0		0	20		0	50		0
Storage Lanes	0		0	0		1	1		0	1		0
Taper Length (ft)	25			25			25			25		
Satd. Flow (prot)	0	1640	0	0	1777	1583	1676	3522	0	1676	3529	0
Flt Permitted		0.994			0.954		0.950			0.950		
Satd. Flow (perm)	0	1640	0	0	1777	1583	1676	3522	0	1676	3529	0
Link Speed (mph)		25			30			40			40	
Link Distance (ft)		267			71			291			254	
Travel Time (s)		7.3			1.6			5.0			4.3	
Peak Hour Factor	0.92	0.92	0.92	0.92	0.92	0.92	0.92	0.92	0.92	0.92	0.92	0.92
Shared Lane Traffic (%)												
Lane Group Flow (vph)	0	92	0	0	28	27	14	1379	0	17	1088	0
Sign Control		Stop			Stop			Free			Free	

Intersection Summary

Area Type:	Other
Control Type:	Unsignalized
Intersection Capacity Utilization	53.7%
	ICU Level of Service A
Analysis Period (min)	15

HCM 6th TWSC  
4: Lemon Street & South Project Access

05/23/2021

Intersection

Int Delay, s/veh 5.7

Movement	EBL	EBT	EBR	WBL	WBT	WBR	NBL	NBT	NBR	SBL	SBT	SBR
Lane Configurations		↕			↕	↕	↕	↕		↕	↕	
Traffic Vol, veh/h	11	2	72	25	1	25	13	1229	40	16	982	19
Future Vol, veh/h	11	2	72	25	1	25	13	1229	40	16	982	19
Conflicting Peds, #/hr	0	0	0	0	0	0	0	0	0	0	0	0
Sign Control	Stop	Stop	Stop	Stop	Stop	Stop	Free	Free	Free	Free	Free	Free
RT Channelized	-	-	None	-	-	None	-	-	None	-	-	None
Storage Length	-	-	-	-	-	0	20	-	-	50	-	-
Veh in Median Storage, #	0	-	-	0	-	-	0	-	-	0	-	-
Grade, %	-	0	-	-	0	-	-	0	-	-	0	-
Peak Hour Factor	92	92	92	92	92	92	92	92	92	92	92	92
Heavy Vehicles, %	2	2	2	2	2	2	2	2	2	2	2	2
Mvmt Flow	12	2	78	27	1	27	14	1336	43	17	1067	21

Major/Minor	Minor2	Minor1	Major1	Major2
Conflicting Flow All	1809	2519	544	1955
Stage 1	1112	1112	-	1386
Stage 2	697	1407	-	569
Critical Hdwy	7.54	6.54	6.94	7.54
Critical Hdwy Stg 1	6.54	5.54	-	6.54
Critical Hdwy Stg 2	6.54	5.54	-	6.54
Follow-up Hdwy	3.52	4.02	3.32	3.52
Pot Cap-1 Maneuver	49	28	483	38
Stage 1	223	282	-	151
Stage 2	398	204	-	474
Platoon blocked, %				
Mov Cap-1 Maneuver	42	26	483	29
Mov Cap-2 Maneuver	42	26	-	29
Stage 1	218	272	-	148
Stage 2	360	200	-	380

Approach	EB	WB	NB	SB
HCM Control Delay, s	47	189.3	0.1	0.2
HCM LOS	E	F		

Minor Lane/Major Mvmt	NBL	NBT	NBR	EBLn	WBLn	WBLn2	SBL	SBT	SBR
Capacity (veh/h)	637	-	-	174	29	388	493	-	-
HCM Lane V/C Ratio	0.022	-	-	0.531	0.975	0.07	0.035	-	-
HCM Control Delay (s)	10.8	-	-	4	356.8	15	12.6	-	-
HCM Lane LOS	B	-	-	E	F	C	B	-	-
HCM 95th %tile Q(veh)	0.1	-	-	2.7	3.2	0.2	0.1	-	-

Lanes, Volumes, Timings

5: Lemon Street & North Project Access/Liberty Avenue

05/23/2021



Lane Group	EBL	EBT	EBR	WBL	WBT	WBR	NBL	NBT	NBR	SBL	SBT	SBR
Lane Configurations		↕	↗		↕		↗	↕↗		↗	↕↗	
Traffic Volume (vph)	59	0	89	34	1	22	121	1130	11	1	878	69
Future Volume (vph)	59	0	89	34	1	22	121	1130	11	1	878	69
Ideal Flow (vphpl)	1900	1900	1900	1900	1900	1900	1800	1900	1900	1800	1900	1900
Storage Length (ft)	0		0	0		0	50		0	50		0
Storage Lanes	0		1	0		0	1		0	1		0
Taper Length (ft)	25			25			25			25		
Satd. Flow (prot)	0	1770	1583	0	1715	0	1676	3536	0	1676	3500	0
Flt Permitted		0.950			0.971		0.950			0.950		
Satd. Flow (perm)	0	1770	1583	0	1715	0	1676	3536	0	1676	3500	0
Link Speed (mph)		30			25			40			40	
Link Distance (ft)		333			454			254			394	
Travel Time (s)		7.6			12.4			4.3			6.7	
Peak Hour Factor	0.92	0.92	0.92	0.92	0.92	0.92	0.92	0.92	0.92	0.92	0.92	0.92
Shared Lane Traffic (%)												
Lane Group Flow (vph)	0	64	97	0	62	0	132	1240	0	1	1029	0
Sign Control		Stop			Stop			Free			Free	

Intersection Summary

Area Type:	Other
Control Type:	Unsignalized
Intersection Capacity Utilization	54.9%
	ICU Level of Service A
Analysis Period (min)	15



HCM 6th TWSC  
5: Lemon Street & North Project Access/Liberty Avenue

05/23/2021

Intersection

Int Delay, s/veh 29.7

Movement	EBL	EBT	EBR	WBL	WBT	WBR	NBL	NBT	NBR	SBL	SBT	SBR
Lane Configurations		↑	↑		↑		↑	↑		↑	↑	
Traffic Vol, veh/h	59	0	89	34	1	22	121	1130	11	1	878	69
Future Vol, veh/h	59	0	89	34	1	22	121	1130	11	1	878	69
Conflicting Peds, #/hr	0	0	0	0	0	0	0	0	0	0	0	0
Sign Control	Stop	Stop	Stop	Stop	Stop	Stop	Free	Free	Free	Free	Free	Free
RT Channelized	-	-	None	-	-	None	-	-	None	-	-	None
Storage Length	-	-	0	-	-	-	50	-	-	50	-	-
Veh in Median Storage, #	0	-	-	0	-	-	-	0	-	-	0	-
Grade, %	-	0	-	-	0	-	-	0	-	-	0	-
Peak Hour Factor	92	92	92	92	92	92	92	92	92	92	92	92
Heavy Vehicles, %	2	2	2	2	2	2	2	2	2	2	2	2
Mvmt Flow	64	0	97	37	1	24	132	1228	12	1	954	75

Major/Minor	Minor2	Minor1	Major1	Major2
Conflicting Flow All	1873	2498	515	1977
Stage 1	994	994	-	1498
Stage 2	879	1504	-	479
Critical Hdwy	7.54	6.54	6.94	7.54
Critical Hdwy Stg 1	6.54	5.54	-	6.54
Critical Hdwy Stg 2	6.54	5.54	-	6.54
Follow-up Hdwy	3.52	4.02	3.32	3.52
Pot Cap-1 Maneuver	44	28	505	37
Stage 1	263	321	-	128
Stage 2	309	183	-	537
Platoon blocked, %				
Mov Cap-1 Maneuver	34	22	505	~ 25
Mov Cap-2 Maneuver	34	22	-	~ 25
Stage 1	211	320	-	103
Stage 2	233	147	-	433

Approach	EB	WB	NB	SB
HCM Control Delay (s)	27.5	\$ 518.8	1.1	0
HCM LOS	F	F		

Minor Lane/Major Mvmt	NBL	NBT	NBR	EBLn	EBLn	WBLn	SBL	SBT	SBR
Capacity (veh/h)	671	-	-	34	505	39	557	-	-
HCM Lane V/C Ratio	0.196	-	-	1.886	0.192	1.589	0.002	-	-
HCM Control Delay (s)	11.7	-	-	\$ 670.3	13.5	\$ 518.8	11.5	-	-
HCM Lane LOS	B	-	-	F	B	F	B	-	-
HCM 95th %tile Q(veh)	0.7	-	-	7.1	0.7	6.5	0	-	-

Notes

~: Volume exceeds capacity    \$: Delay exceeds 300s    +: Computation Not Defined    \*: All major volume in platoon

## Appendix C – Lemon Street Improvement Plans

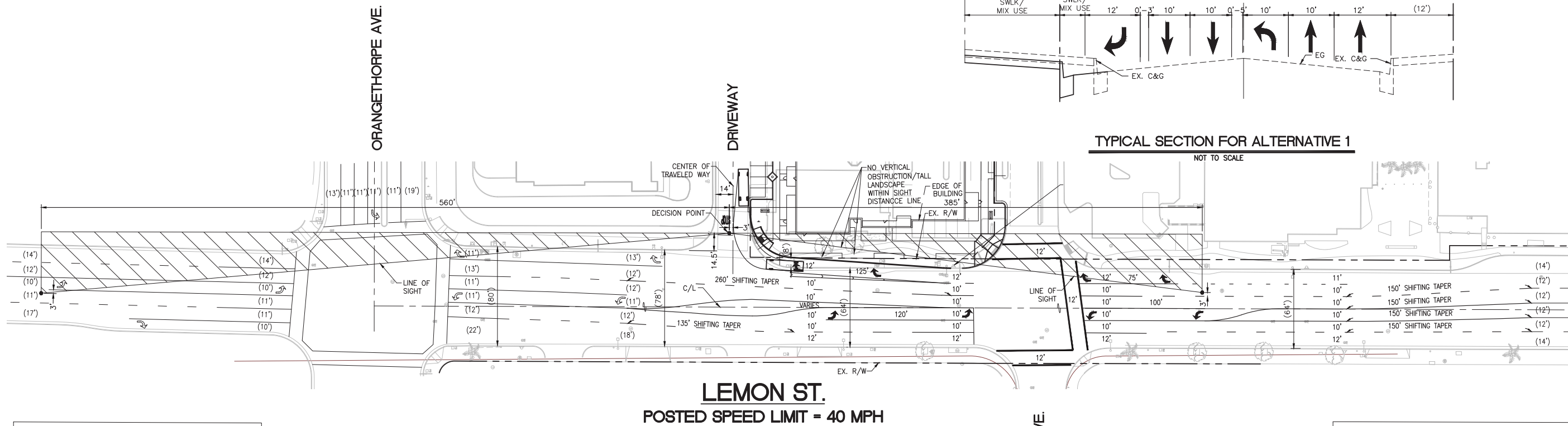
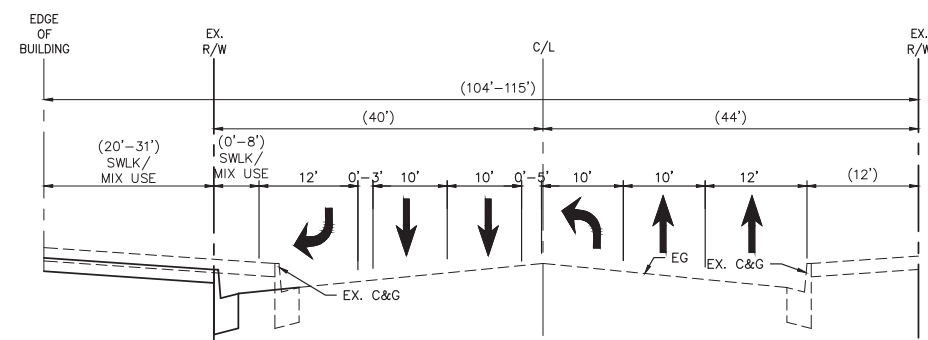
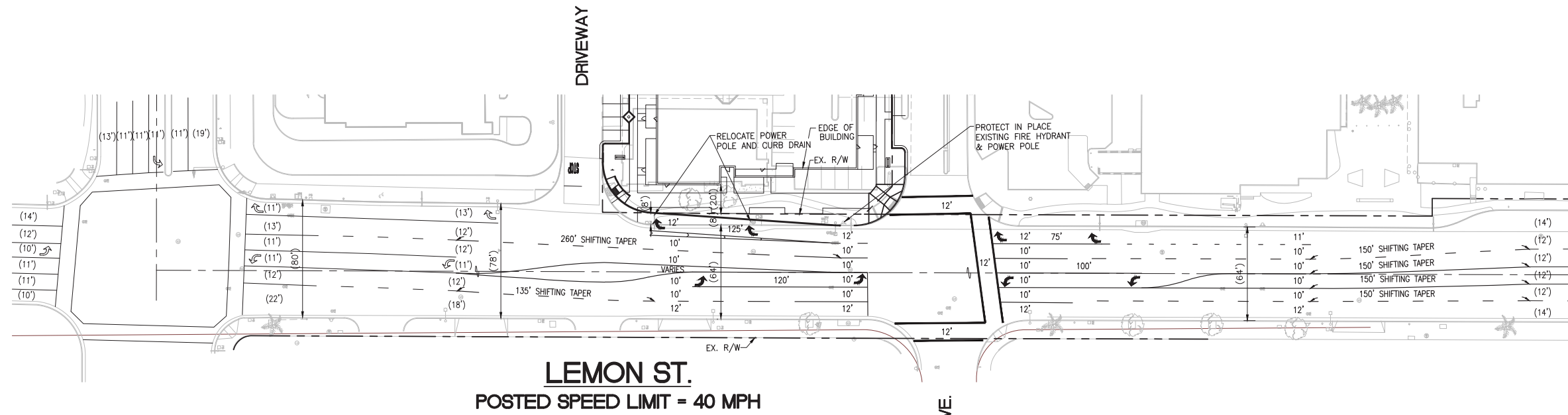

TEMPLATE USED:  
AASHTO (US CUSTOMARY)  
SU-30 - SINGLE UNIT TRUCK  
WIDTH: 8.000 FT  
LENGTH: 30.000 FT

NOTE:  
SIGHT DISTANCE EVALUATION WAS PERFORMED PER  
AASHTO GREENBOOK - INTERSECTION SIGHT DISTANCE.

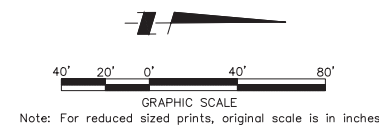

**ALTERNATIVE 1:**  
PUSH BACK NORTH WEST CORNER OF  
DRIVEWAY 8' AND ADJUST STRIPING TO  
ACCOMMODATE A RIGHT TURN LANE INTO  
DRIVEWAY.

PLANS PREPARED BY: <b>PSOMAS</b> 5 Hutton Centre Drive Suite 200 Santa Ana, CA 92707 (714) 751-7373 Fax(714) 545-8883	<b>LEMON ST. BETWEEN LIBERTY AVE. &amp; ORANGETHORPE AVE.</b>		DATE: 03/15/21	SHEET
	ALTERNATIVE 1 DESIGN, SIGHT DISTANCE, AND TRUCK TURNING RADIUS EVALUATION		SCALE: 1"=40'	1
	IN THE CITY OF FULLERTON      COUNTY OF ORANGE      STATE OF CALIFORNIA		PROJECT NUMBER: 3FUL020101	OF

## Appendix D – HCM/Synchro Reports – Opening Year Conditions

Lanes, Volumes, Timings  
1: Harbor Boulevard & Orangethorpe Avenue

05/23/2021



Lane Group	EBL	EBT	EBR	WBU	WBL	WBT	WBR	NBL	NBT	NBR	SBU	SBL
Lane Configurations	↔	↑↑↑	↗		↖	↑↑↑	↗	↔	↑↑	↗		↔
Traffic Volume (vph)	188	830	204	3	150	482	165	112	1209	189	5	192
Future Volume (vph)	188	830	204	3	150	482	165	112	1209	189	5	192
Ideal Flow (vphpl)	1800	1900	1900	1800	1800	1900	1900	1750	1900	1900	1750	1750
Storage Length (ft)	200		130		240		140	120		250		270
Storage Lanes	1		1		1		1	2		0		2
Taper Length (ft)	90				60			90				100
Satd. Flow (prot)	1676	5085	1583	0	1676	5085	1583	3162	3539	1583	0	3162
Flt Permitted	0.950				0.950			0.950				0.950
Satd. Flow (perm)	1676	5085	1583	0	1676	5085	1583	3162	3539	1583	0	3162
Right Turn on Red			Yes				Yes			Yes		
Satd. Flow (RTOR)			204				179			197		
Link Speed (mph)		40				40			40			
Link Distance (ft)		787				701			655			
Travel Time (s)		13.4				11.9			11.2			
Peak Hour Factor	0.92	0.92	0.92	0.92	0.92	0.92	0.92	0.92	0.92	0.92	0.92	0.92
Shared Lane Traffic (%)												
Lane Group Flow (vph)	204	902	222	0	166	524	179	122	1314	205	0	214
Turn Type	Prot	NA	Perm	Prot	Prot	NA	Perm	Prot	NA	Perm	Prot	Prot
Protected Phases	7	4		3	3	8		5	2		1	1
Permitted Phases			4				8			2		
Total Split (s)	18.0	21.0	21.0	18.0	18.0	21.0	21.0	16.0	35.0	35.0	16.0	16.0
Total Lost Time (s)	4.5	4.5	4.5		4.5	4.5	4.5	4.5	4.5	4.5		4.5
Act Effct Green (s)	12.9	16.5	16.5		12.1	15.7	15.7	8.7	30.6	30.6		10.3
Actuated g/C Ratio	0.15	0.19	0.19		0.14	0.18	0.18	0.10	0.35	0.35		0.12
v/c Ratio	0.83	0.94	0.48		0.72	0.57	0.42	0.39	1.06	0.30		0.57
Control Delay	64.3	54.4	10.1		54.4	35.9	8.4	40.8	74.5	5.0		43.3
Queue Delay	0.0	0.0	0.0		0.0	0.0	0.0	0.0	0.0	0.0		0.0
Total Delay	64.3	54.4	10.1		54.4	35.9	8.4	40.8	74.5	5.0		43.3
LOS	E	D	B		D	D	A	D	E	A		D
Approach Delay		48.5				33.8			63.4			
Approach LOS		D				C			E			
Queue Length 50th (ft)	113	187	9		90	100	0	34	~447	3		59
Queue Length 95th (ft)	#230	#274	70		#173	136	54	59	#580	49		95
Internal Link Dist (ft)		707				621			575			
Turn Bay Length (ft)	200		130		240		140	120		250		270
Base Capacity (vph)	258	959	464		258	959	443	415	1234	680		415
Starvation Cap Reductn	0	0	0		0	0	0	0	0	0		0
Spillback Cap Reductn	0	0	0		0	0	0	0	0	0		0
Storage Cap Reductn	0	0	0		0	0	0	0	0	0		0
Reduced v/c Ratio	0.79	0.94	0.48		0.64	0.55	0.40	0.29	1.06	0.30		0.52

Intersection Summary

Area Type:	Other
Cycle Length:	90
Actuated Cycle Length:	87.6
Control Type:	Actuated-Uncoordinated
Maximum v/c Ratio:	1.06
Intersection Signal Delay:	45.9
Intersection LOS:	D



Lanes, Volumes, Timings  
 1: Harbor Boulevard & Orangethorpe Avenue

05/23/2021



Lane Group	SBT	SBR
Lane Configurations	↑↑↑	
Traffic Volume (vph)	1517	128
Future Volume (vph)	1517	128
Ideal Flow (vphpl)	1900	1900
Storage Length (ft)		160
Storage Lanes		0
Taper Length (ft)		
Satd. Flow (prot)	5024	0
Flt Permitted		
Satd. Flow (perm)	5024	0
Right Turn on Red		Yes
Satd. Flow (RTOR)	16	
Link Speed (mph)	40	
Link Distance (ft)	935	
Travel Time (s)	15.9	
Peak Hour Factor	0.92	0.92
Shared Lane Traffic (%)		
Lane Group Flow (vph)	1788	0
Turn Type	NA	
Protected Phases	6	
Permitted Phases		
Total Split (s)	35.0	
Total Lost Time (s)	4.5	
Act Effct Green (s)	34.5	
Actuated g/C Ratio	0.39	
v/c Ratio	0.90	
Control Delay	34.2	
Queue Delay	0.0	
Total Delay	34.2	
LOS	C	
Approach Delay	35.1	
Approach LOS	D	
Queue Length 50th (ft)	355	
Queue Length 95th (ft)	#500	
Internal Link Dist (ft)	855	
Turn Bay Length (ft)		
Base Capacity (vph)	1987	
Starvation Cap Reductn	0	
Spillback Cap Reductn	0	
Storage Cap Reductn	0	
Reduced v/c Ratio	0.90	

Intersection Summary

# Lanes, Volumes, Timings

## 1: Harbor Boulevard & Orangethorpe Avenue

05/23/2021

Intersection Capacity Utilization 79.5%      ICU Level of Service D

Analysis Period (min) 15









~ Volume exceeds capacity, queue is theoretically infinite.

Queue shown is maximum after two cycles.

# 95th percentile volume exceeds capacity, queue may be longer.

Queue shown is maximum after two cycles.

Splits and Phases: 1: Harbor Boulevard & Orangethorpe Avenue

 Ø1	 Ø2	 Ø3	 Ø4
16 s	35 s	18 s	21 s
 Ø5	 Ø6	 Ø7	 Ø8
16 s	35 s	18 s	21 s



Lanes, Volumes, Timings  
 2: Pomona Avenue & Orangethorpe Avenue

05/23/2021



Lane Group	SBT	SBR
Lane Configurations	7	66
Traffic Volume (vph)	7	66
Future Volume (vph)	7	66
Ideal Flow (vphpl)	1900	1900
Storage Length (ft)		0
Storage Lanes		0
Taper Length (ft)		
Satd. Flow (prot)	1611	0
Flt Permitted		
Satd. Flow (perm)	1611	0
Right Turn on Red		Yes
Satd. Flow (RTOR)	72	
Link Speed (mph)	25	
Link Distance (ft)	398	
Travel Time (s)	10.9	
Peak Hour Factor	0.92	0.92
Shared Lane Traffic (%)		
Lane Group Flow (vph)	80	0
Turn Type	NA	
Protected Phases	6	
Permitted Phases		
Total Split (s)	12.0	
Total Lost Time (s)	4.5	
Act Effct Green (s)	7.0	
Actuated g/C Ratio	0.18	
v/c Ratio	0.23	
Control Delay	7.9	
Queue Delay	0.0	
Total Delay	7.9	
LOS	A	
Approach Delay	14.0	
Approach LOS	B	
Queue Length 50th (ft)	1	
Queue Length 95th (ft)	28	
Internal Link Dist (ft)	318	
Turn Bay Length (ft)		
Base Capacity (vph)	375	
Starvation Cap Reductn	0	
Spillback Cap Reductn	0	
Storage Cap Reductn	0	
Reduced v/c Ratio	0.21	
Intersection Summary		

Lanes, Volumes, Timings  
2: Pomona Avenue & Orangethorpe Avenue

05/23/2021

Intersection Capacity Utilization 50.5%      ICU Level of Service A  
Analysis Period (min) 15

Splits and Phases: 2: Pomona Avenue & Orangethorpe Avenue

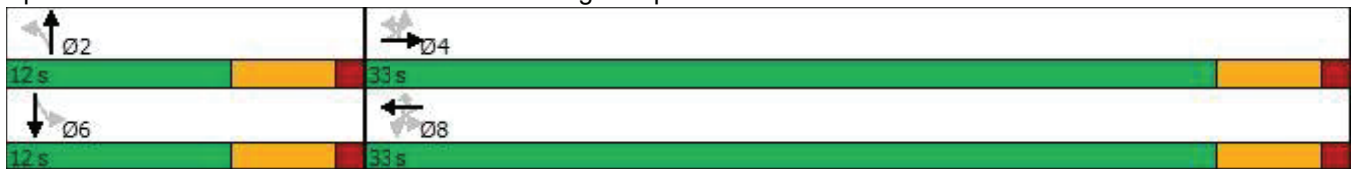





Lanes, Volumes, Timings  
 3: Lemon Street & Orangethorpe Avenue

05/23/2021

Lane Group	SBR
Lane Configurations	
Traffic Volume (vph)	81
Future Volume (vph)	81
Ideal Flow (vphpl)	1900
Storage Length (ft)	175
Storage Lanes	1
Taper Length (ft)	
Satd. Flow (prot)	1583
Flt Permitted	
Satd. Flow (perm)	1583
Right Turn on Red	Yes
Satd. Flow (RTOR)	127
Link Speed (mph)	
Link Distance (ft)	
Travel Time (s)	
Peak Hour Factor	0.92
Shared Lane Traffic (%)	
Lane Group Flow (vph)	88
Turn Type	Perm
Protected Phases	
Permitted Phases	6
Total Split (s)	29.0
Total Lost Time (s)	4.5
Act Effct Green (s)	24.2
Actuated g/C Ratio	0.28
v/c Ratio	0.17
Control Delay	2.8
Queue Delay	0.0
Total Delay	2.8
LOS	A
Approach Delay	
Approach LOS	
Queue Length 50th (ft)	0
Queue Length 95th (ft)	17
Internal Link Dist (ft)	
Turn Bay Length (ft)	175
Base Capacity (vph)	536
Starvation Cap Reductn	0
Spillback Cap Reductn	0
Storage Cap Reductn	0
Reduced v/c Ratio	0.16
Intersection Summary	

Lanes, Volumes, Timings  
 3: Lemon Street & Orangethorpe Avenue

05/23/2021

Intersection Capacity Utilization 81.6% ICU Level of Service D

Analysis Period (min) 15

# 95th percentile volume exceeds capacity, queue may be longer.





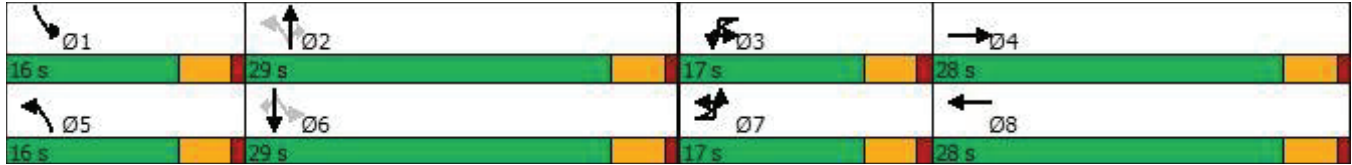















Queue shown is maximum after two cycles.

Splits and Phases: 3: Lemon Street & Orangethorpe Avenue



Lanes, Volumes, Timings  
 4: Lemon Street & South Project Access

05/23/2021

												
Lane Group	EBL	EBT	EBR	WBL	WBT	WBR	NBL	NBT	NBR	SBL	SBT	SBR
Lane Configurations												
Traffic Volume (vph)	2	0	45	0	0	4	4	943	4	0	1095	27
Future Volume (vph)	2	0	45	0	0	4	4	943	4	0	1095	27
Ideal Flow (vphpl)	1900	1900	1900	1900	1900	1900	1800	1900	1900	1800	1900	1900
Storage Length (ft)	0		0	0		0	20		0	50		0
Storage Lanes	0		0	0		1	1		0	1		0
Taper Length (ft)	25			25			25			25		
Satd. Flow (prot)	0	1617	0	0	1863	1583	1676	3536	0	1765	3525	0
Flt Permitted		0.998					0.950					
Satd. Flow (perm)	0	1617	0	0	1863	1583	1676	3536	0	1765	3525	0
Link Speed (mph)		25			30			40			40	
Link Distance (ft)		267			71			291			254	
Travel Time (s)		7.3			1.6			5.0			4.3	
Peak Hour Factor	0.92	0.92	0.92	0.92	0.92	0.92	0.92	0.92	0.92	0.92	0.92	0.92
Shared Lane Traffic (%)												
Lane Group Flow (vph)	0	51	0	0	0	4	4	1029	0	0	1219	0
Sign Control		Stop			Stop			Free			Free	
<b>Intersection Summary</b>												
Area Type:	Other											
Control Type:	Unsignalized											
Intersection Capacity Utilization	42.9%					ICU Level of Service A						
Analysis Period (min)	15											

HCM 6th TWSC  
4: Lemon Street & South Project Access

05/23/2021

Intersection												
Int Delay, s/veh	0.4											
Movement	EBL	EBT	EBR	WBL	WBT	WBR	NBL	NBT	NBR	SBL	SBT	SBR
Lane Configurations		↕			↕	↕	↕	↕		↕	↕	
Traffic Vol, veh/h	2	0	45	0	0	4	4	943	4	0	1095	27
Future Vol, veh/h	2	0	45	0	0	4	4	943	4	0	1095	27
Conflicting Peds, #/hr	0	0	0	0	0	0	0	0	0	0	0	0
Sign Control	Stop	Stop	Stop	Stop	Stop	Stop	Free	Free	Free	Free	Free	Free
RT Channelized	-	-	None	-	-	None	-	-	None	-	-	None
Storage Length	-	-	-	-	-	0	20	-	-	50	-	-
Veh in Median Storage, #	0	-	-	0	-	-	0	-	-	0	-	-
Grade, %	-	0	-	-	0	-	-	0	-	-	0	-
Peak Hour Factor	92	92	92	92	92	92	92	92	92	92	92	92
Heavy Vehicles, %	2	2	2	2	2	2	2	2	2	2	2	2
Mvmt Flow	2	0	49	0	0	4	4	1025	4	0	1190	29

Major/Minor	Minor2		Minor1		Major1		Major2					
Conflicting Flow All	1726	2242	610	1630	2254	515	1219	0	0	1029	0	0
Stage 1	1205	1205	-	1035	1035	-	-	-	-	-	-	-
Stage 2	521	1037	-	595	1219	-	-	-	-	-	-	-
Critical Hdwy	7.54	6.54	6.94	7.54	6.54	6.94	4.14	-	-	4.14	-	-
Critical Hdwy Stg 1	6.54	5.54	-	6.54	5.54	-	-	-	-	-	-	-
Critical Hdwy Stg 2	6.54	5.54	-	6.54	5.54	-	-	-	-	-	-	-
Follow-up Hdwy	3.52	4.02	3.32	3.52	4.02	3.32	2.22	-	-	2.22	-	-
Pot Cap-1 Maneuver	57	42	437	67	41	505	568	-	-	671	-	-
Stage 1	195	255	-	248	307	-	-	-	-	-	-	-
Stage 2	507	307	-	458	251	-	-	-	-	-	-	-
Platoon blocked, %								-	-	-	-	-
Mov Cap-1 Maneuver	56	42	437	59	41	505	568	-	-	671	-	-
Mov Cap-2 Maneuver	56	42	-	59	41	-	-	-	-	-	-	-
Stage 1	194	255	-	246	305	-	-	-	-	-	-	-
Stage 2	499	305	-	407	251	-	-	-	-	-	-	-

Approach	EB	WB	NB	SB
HCM Control Delay, s	7.5	12.2	0	0
HCM LOS	C	B		

Minor Lane/Major Mvmt	NBL	NBT	NBR	EBLn	WBLn	WBLn2	SBL	SBT	SBR
Capacity (veh/h)	568	-	-	339	-	505	671	-	-
HCM Lane V/C Ratio	0.008	-	-	0.151	-	0.009	-	-	-
HCM Control Delay (s)	11.4	-	-	17.5	0	12.2	0	-	-
HCM Lane LOS	B	-	-	C	A	B	A	-	-
HCM 95th %tile Q(veh)	0	-	-	0.5	-	0	0	-	-



Lanes, Volumes, Timings

5: Lemon Street & North Project Access/Liberty Avenue

05/23/2021



Lane Group	EBL	EBT	EBR	WBL	WBT	WBR	NBL	NBT	NBR	SBL	SBT	SBR
Lane Configurations		↔	↔		↔		↔	↕		↔	↕	
Traffic Volume (vph)	18	0	59	52	2	12	23	801	95	29	1010	18
Future Volume (vph)	18	0	59	52	2	12	23	801	95	29	1010	18
Ideal Flow (vphpl)	1900	1900	1900	1900	1900	1900	1800	1900	1900	1800	1900	1900
Storage Length (ft)	0		0	0		0	50		0	50		0
Storage Lanes	0		1	0		0	1		0	1		0
Taper Length (ft)	25			25			25			25		
Satd. Flow (prot)	0	1770	1583	0	1749	0	1676	3483	0	1676	3529	0
Flt Permitted		0.950			0.962		0.950			0.950		
Satd. Flow (perm)	0	1770	1583	0	1749	0	1676	3483	0	1676	3529	0
Link Speed (mph)		30			25			40			40	
Link Distance (ft)		333			454			254			394	
Travel Time (s)		7.6			12.4			4.3			6.7	
Peak Hour Factor	0.92	0.92	0.92	0.92	0.92	0.92	0.92	0.92	0.92	0.92	0.92	0.92
Shared Lane Traffic (%)												
Lane Group Flow (vph)	0	20	64	0	72	0	25	974	0	32	1118	0
Sign Control		Stop			Stop			Free			Free	

Intersection Summary

Area Type:	Other
Control Type:	Unsignalized
Intersection Capacity Utilization	45.9%
	ICU Level of Service A
Analysis Period (min)	15

HCM 6th TWSC  
 5: Lemon Street & North Project Access/Liberty Avenue

05/23/2021

Intersection

Int Delay, s/veh 8.5

Movement	EBL	EBT	EBR	WBL	WBT	WBR	NBL	NBT	NBR	SBL	SBT	SBR
Lane Configurations		↕	↗		↕		↗	↕		↗	↕	
Traffic Vol, veh/h	18	0	59	52	2	12	23	801	95	29	1010	18
Future Vol, veh/h	18	0	59	52	2	12	23	801	95	29	1010	18
Conflicting Peds, #/hr	0	0	0	0	0	0	0	0	0	0	0	0
Sign Control	Stop	Stop	Stop	Stop	Stop	Stop	Free	Free	Free	Free	Free	Free
RT Channelized	-	-	None	-	-	None	-	-	None	-	-	None
Storage Length	-	-	0	-	-	-	50	-	-	50	-	-
Veh in Median Storage, #	0	-	-	0	-	-	0	-	-	0	-	-
Grade, %	-	0	-	-	0	-	-	0	-	-	0	-
Peak Hour Factor	92	92	92	92	92	92	92	92	92	92	92	92
Heavy Vehicles, %	2	2	2	2	2	2	2	2	2	2	2	2
Mvmt Flow	20	0	64	57	2	13	25	871	103	32	1098	20

Major/Minor	Minor2	Minor1		Major1		Major2						
Conflicting Flow All	1659	2196	559	1586	2155	487	1118	0	0	974	0	0
Stage 1	1172	1172	-	973	973	-	-	-	-	-	-	-
Stage 2	487	1024	-	613	1182	-	-	-	-	-	-	-
Critical Hdwy	7.54	6.54	6.94	7.54	6.54	6.94	4.14	-	-	4.14	-	-
Critical Hdwy Stg 1	6.54	5.54	-	6.54	5.54	-	-	-	-	-	-	-
Critical Hdwy Stg 2	6.54	5.54	-	6.54	5.54	-	-	-	-	-	-	-
Follow-up Hdwy	3.52	4.02	3.32	3.52	4.02	3.32	2.22	-	-	2.22	-	-
Pot Cap-1 Maneuver	64	44	472	73	47	526	620	-	-	704	-	-
Stage 1	204	264	-	271	329	-	-	-	-	-	-	-
Stage 2	531	311	-	446	262	-	-	-	-	-	-	-
Platoon blocked, %								-	-	-	-	-
Mov Cap-1 Maneuver	56	40	472	59	43	526	620	-	-	704	-	-
Mov Cap-2 Maneuver	56	40	-	59	43	-	-	-	-	-	-	-
Stage 1	196	252	-	260	316	-	-	-	-	-	-	-
Stage 2	494	299	-	368	250	-	-	-	-	-	-	-

Approach	EB	WB	NB	SB
HCM Control Delay, s	34.1	222.6	0.3	0.3
HCM LOS	D	F		

Minor Lane/Major Mvmt	NBL	NBT	NBR	EBLn	EBLn1	WBLn	SBL	SBT	SBR
Capacity (veh/h)	620	-	-	56	472	69	704	-	-
HCM Lane V/C Ratio	0.04	-	-	0.349	0.136	1.04	0.045	-	-
HCM Control Delay (s)	11.1	-	-	100.5	13.8	222.6	10.4	-	-
HCM Lane LOS	B	-	-	F	B	F	B	-	-
HCM 95th %tile Q(veh)	0.1	-	-	1.3	0.5	5.4	0.1	-	-

Lanes, Volumes, Timings  
1: Harbor Boulevard & Orangethorpe Avenue

05/27/2021



Lane Group	EBU	EBL	EBT	EBR	WBU	WBL	WBT	WBR	NBU	NBL	NBT	NBR
Lane Configurations		↔	↔↔↔	↔		↔	↔↔↔	↔		↔↔	↔↔	↔
Traffic Volume (vph)	2	240	800	183	15	235	961	198	1	237	1248	232
Future Volume (vph)	2	240	800	183	15	235	961	198	1	237	1248	232
Ideal Flow (vphpl)	1800	1800	1900	1900	1800	1800	1900	1900	1750	1750	1900	1900
Storage Length (ft)		200		130		240		140		120		250
Storage Lanes		1		1		1		1		2		0
Taper Length (ft)		90				60				90		
Satd. Flow (prot)	0	1676	5085	1583	0	1676	5085	1583	0	3162	3539	1583
Flt Permitted		0.950				0.950				0.950		
Satd. Flow (perm)	0	1676	5085	1583	0	1676	5085	1583	0	3162	3539	1583
Right Turn on Red				Yes				Yes				Yes
Satd. Flow (RTOR)				156				154				198
Link Speed (mph)			40				40				40	
Link Distance (ft)			787				701				655	
Travel Time (s)			13.4				11.9				11.2	
Peak Hour Factor	0.92	0.92	0.92	0.92	0.92	0.92	0.92	0.92	0.92	0.92	0.92	0.92
Shared Lane Traffic (%)												
Lane Group Flow (vph)	0	263	870	199	0	271	1045	215	0	259	1357	252
Turn Type	Prot	Prot	NA	Perm	Prot	Prot	NA	Perm	Prot	Prot	NA	Perm
Protected Phases	7	7	4		3	3	8		5	5	2	
Permitted Phases				4				8				2
Total Split (s)	24.0	24.0	25.0	25.0	27.0	27.0	28.0	28.0	22.0	22.0	44.0	44.0
Total Lost Time (s)		4.5	4.5	4.5		4.5	4.5	4.5		4.5	4.5	4.5
Act Effct Green (s)		18.9	21.7	21.7		20.7	23.5	23.5		14.0	39.5	39.5
Actuated g/C Ratio		0.17	0.20	0.20		0.19	0.21	0.21		0.13	0.36	0.36
v/c Ratio		0.91	0.86	0.45		0.86	0.96	0.47		0.64	1.06	0.36
Control Delay		79.3	52.9	14.3		67.9	61.7	15.6		52.5	78.3	8.0
Queue Delay		0.0	0.0	0.0		0.0	0.0	0.0		0.0	0.0	0.0
Total Delay		79.3	52.9	14.3		67.9	61.7	15.6		52.5	78.3	8.0
LOS		E	D	B		E	E	B		D	E	A
Approach Delay			52.3				56.3				65.2	
Approach LOS			D				E				E	
Queue Length 50th (ft)		183	223	26		183	269	36		90	~559	25
Queue Length 95th (ft)		#332	#301	94		#312	#361	107		129	#696	84
Internal Link Dist (ft)			707				621				575	
Turn Bay Length (ft)		200		130		240		140		120		250
Base Capacity (vph)		299	1009	438		344	1092	461		506	1277	698
Starvation Cap Reductn		0	0	0		0	0	0		0	0	0
Spillback Cap Reductn		0	0	0		0	0	0		0	0	0
Storage Cap Reductn		0	0	0		0	0	0		0	0	0
Reduced v/c Ratio		0.88	0.86	0.45		0.79	0.96	0.47		0.51	1.06	0.36

Intersection Summary

Area Type:	Other
Cycle Length:	110
Actuated Cycle Length:	109.4
Control Type:	Actuated-Uncoordinated
Maximum v/c Ratio:	1.06
Intersection Signal Delay:	57.5
Intersection LOS:	E

Lanes, Volumes, Timings  
 1: Harbor Boulevard & Orangethorpe Avenue

05/27/2021



Lane Group	SBU	SBL	SBT	SBR
Lane Configurations				
Traffic Volume (vph)	13	201	1205	212
Future Volume (vph)	13	201	1205	212
Ideal Flow (vphpl)	1750	1750	1900	1900
Storage Length (ft)		270		160
Storage Lanes		2		0
Taper Length (ft)		100		
Satd. Flow (prot)	0	3162	4973	0
Flt Permitted		0.950		
Satd. Flow (perm)	0	3162	4973	0
Right Turn on Red				Yes
Satd. Flow (RTOR)			32	
Link Speed (mph)			40	
Link Distance (ft)			935	
Travel Time (s)			15.9	
Peak Hour Factor	0.92	0.92	0.92	0.92
Shared Lane Traffic (%)				
Lane Group Flow (vph)	0	232	1540	0
Turn Type	Prot	Prot	NA	
Protected Phases	1	1	6	
Permitted Phases				
Total Split (s)	14.0	14.0	36.0	
Total Lost Time (s)		4.5	4.5	
Act Effct Green (s)		9.5	35.0	
Actuated g/C Ratio		0.09	0.32	
v/c Ratio		0.85	0.96	
Control Delay		76.2	50.9	
Queue Delay		0.0	0.0	
Total Delay		76.2	50.9	
LOS		E	D	
Approach Delay			54.2	
Approach LOS			D	
Queue Length 50th (ft)		84	383	
Queue Length 95th (ft)		#153	#532	
Internal Link Dist (ft)			855	
Turn Bay Length (ft)		270		
Base Capacity (vph)		274	1610	
Starvation Cap Reductn		0	0	
Spillback Cap Reductn		0	0	
Storage Cap Reductn		0	0	
Reduced v/c Ratio		0.85	0.96	
Intersection Summary				

Lanes, Volumes, Timings  
 1: Harbor Boulevard & Orangethorpe Avenue

05/27/2021

Intersection Capacity Utilization 88.8%      ICU Level of Service E

Analysis Period (min) 15

~ Volume exceeds capacity, queue is theoretically infinite.

Queue shown is maximum after two cycles.

# 95th percentile volume exceeds capacity, queue may be longer.

Queue shown is maximum after two cycles.

Splits and Phases: 1: Harbor Boulevard & Orangethorpe Avenue

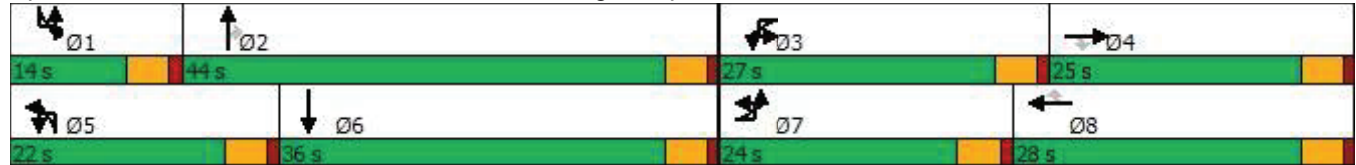



Lanes, Volumes, Timings  
2: Pomona Avenue & Orangethorpe Avenue

05/27/2021



Lane Group	EBU	EBL	EBT	EBR	WBU	WBL	WBT	WBR	NBL	NBT	NBR	SBL
Lane Configurations		↔	↑↑↑				↔	↑↑	↔	↔	↔	↔
Traffic Volume (vph)	5	169	829	82	11	51	952	161	90	39	77	150
Future Volume (vph)	5	169	829	82	11	51	952	161	90	39	77	150
Ideal Flow (vphpl)	1800	1800	1900	1900	1800	1800	1900	1900	1800	1900	1900	1800
Storage Length (ft)		140		0		150		70	95		0	70
Storage Lanes		1		0		1		1	1		0	1
Taper Length (ft)		60				70			30			60
Satd. Flow (prot)	0	1676	5019	0	0	1676	3539	1583	1676	1676	0	1676
Flt Permitted		0.242				0.275			0.660			0.676
Satd. Flow (perm)	0	427	5019	0	0	485	3539	1583	1165	1676	0	1193
Right Turn on Red				Yes				Yes			Yes	
Satd. Flow (RTOR)			60					175		84		
Link Speed (mph)			40				40			25		
Link Distance (ft)			701				647			214		
Travel Time (s)			11.9				11.0			5.8		
Peak Hour Factor	0.92	0.92	0.92	0.92	0.92	0.92	0.92	0.92	0.92	0.92	0.92	0.92
Shared Lane Traffic (%)												
Lane Group Flow (vph)	0	189	990	0	0	67	1035	175	98	126	0	163
Turn Type	Perm	Perm	NA		Perm	Perm	NA	Perm	Perm	NA		Perm
Protected Phases			4				8			2		
Permitted Phases	4	4			8	8		8	2			6
Total Split (s)	40.0	40.0	40.0		40.0	40.0	40.0	40.0	15.0	15.0		15.0
Total Lost Time (s)		4.5	4.5			4.5	4.5	4.5	4.5	4.5		4.5
Act Effct Green (s)		29.5	29.5			29.5	29.5	29.5	9.8	9.8		9.8
Actuated g/C Ratio		0.61	0.61			0.61	0.61	0.61	0.20	0.20		0.20
v/c Ratio		0.73	0.32			0.23	0.48	0.17	0.42	0.31		0.68
Control Delay		27.6	4.6			6.5	6.1	1.2	24.8	11.1		37.5
Queue Delay		0.0	0.0			0.0	0.0	0.0	0.0	0.0		0.0
Total Delay		27.6	4.6			6.5	6.1	1.2	24.8	11.1		37.5
LOS		C	A			A	A	A	C	B		D
Approach Delay			8.2				5.4			17.0		
Approach LOS			A				A			B		
Queue Length 50th (ft)		32	39			7	72	0	25	10		44
Queue Length 95th (ft)		#140	54			22	103	15	67	49		#132
Internal Link Dist (ft)			621				567			134		
Turn Bay Length (ft)		140				150		70	95			70
Base Capacity (vph)		318	3759			361	2640	1225	257	435		263
Starvation Cap Reductn		0	0			0	0	0	0	0		0
Spillback Cap Reductn		0	0			0	0	0	0	0		0
Storage Cap Reductn		0	0			0	0	0	0	0		0
Reduced v/c Ratio		0.59	0.26			0.19	0.39	0.14	0.38	0.29		0.62

Intersection Summary

Area Type: Other  
 Cycle Length: 55  
 Actuated Cycle Length: 48.5  
 Control Type: Actuated-Uncoordinated  
 Maximum v/c Ratio: 0.73  
 Intersection Signal Delay: 9.4                      Intersection LOS: A

Lanes, Volumes, Timings  
 2: Pomona Avenue & Orangethorpe Avenue

05/27/2021



Lane Group	SBT	SBR
Lane Configurations		
Traffic Volume (vph)	36	104
Future Volume (vph)	36	104
Ideal Flow (vphpl)	1900	1900
Storage Length (ft)		0
Storage Lanes		0
Taper Length (ft)		
Satd. Flow (prot)	1654	0
Flt Permitted		
Satd. Flow (perm)	1654	0
Right Turn on Red		Yes
Satd. Flow (RTOR)	113	
Link Speed (mph)	25	
Link Distance (ft)	398	
Travel Time (s)	10.9	
Peak Hour Factor	0.92	0.92
Shared Lane Traffic (%)		
Lane Group Flow (vph)	152	0
Turn Type	NA	
Protected Phases	6	
Permitted Phases		
Total Split (s)	15.0	
Total Lost Time (s)	4.5	
Act Effct Green (s)	9.8	
Actuated g/C Ratio	0.20	
v/c Ratio	0.36	
Control Delay	10.2	
Queue Delay	0.0	
Total Delay	10.2	
LOS	B	
Approach Delay	24.3	
Approach LOS	C	
Queue Length 50th (ft)	9	
Queue Length 95th (ft)	51	
Internal Link Dist (ft)	318	
Turn Bay Length (ft)		
Base Capacity (vph)	453	
Starvation Cap Reductn	0	
Spillback Cap Reductn	0	
Storage Cap Reductn	0	
Reduced v/c Ratio	0.34	
Intersection Summary		

Lanes, Volumes, Timings  
2: Pomona Avenue & Orangethorpe Avenue

05/27/2021

Intersection Capacity Utilization 67.0%      ICU Level of Service C

Analysis Period (min) 15

# 95th percentile volume exceeds capacity, queue may be longer.

Queue shown is maximum after two cycles.

Splits and Phases: 2: Pomona Avenue & Orangethorpe Avenue



### Lanes, Volumes, Timings 3: Lemon Street & Orangethorpe Avenue

05/27/2021



Lane Group	EBU	EBL	EBT	EBR	WBU	WBL	WBT	WBR	NBL	NBT	NBR	SBL
Lane Configurations		3	↑↑↑			3	↑↑		↑	↑↑	↑	↑
Traffic Volume (vph)	2	192	864	216	4	266	885	187	322	954	110	185
Future Volume (vph)	2	192	864	216	4	266	885	187	322	954	110	185
Ideal Flow (vphpl)	1800	1800	1900	1900	1750	1750	1900	1900	1800	1900	1900	1800
Storage Length (ft)		140		0		170		0	200		130	145
Storage Lanes		1		0		2		0	1		1	1
Taper Length (ft)		115				120			90			105
Satd. Flow (prot)	0	1676	4933	0	0	3162	3447	0	1676	3539	1583	1676
Flt Permitted		0.950				0.950			0.129			0.151
Satd. Flow (perm)	0	1676	4933	0	0	3162	3447	0	228	3539	1583	266
Right Turn on Red				Yes				Yes			Yes	
Satd. Flow (RTOR)			55				24				104	
Link Speed (mph)			40				40			40		
Link Distance (ft)			647				859			670		
Travel Time (s)			11.0				14.6			11.4		
Peak Hour Factor	0.92	0.92	0.92	0.92	0.92	0.92	0.92	0.92	0.92	0.92	0.92	0.92
Shared Lane Traffic (%)												
Lane Group Flow (vph)	0	211	1174	0	0	293	1165	0	350	1037	120	201
Turn Type	Prot	Prot	NA		Prot	Prot	NA		pm+pt	NA	Perm	pm+pt
Protected Phases	7	7	4		3	3	8		5	2		1
Permitted Phases									2		2	6
Total Split (s)	17.0	17.0	36.0		21.0	21.0	40.0		22.0	39.0	39.0	14.0
Total Lost Time (s)		4.5	4.5			4.5	4.5		4.5	4.5	4.5	4.5
Act Effct Green (s)		12.5	33.4			14.6	35.5		48.5	34.5	34.5	36.0
Actuated g/C Ratio		0.11	0.30			0.13	0.32		0.44	0.31	0.31	0.33
v/c Ratio		1.11	0.77			0.70	1.03		1.06	0.94	0.21	0.97
Control Delay		143.6	37.4			54.6	72.0		96.8	52.5	8.2	82.9
Queue Delay		0.0	0.0			0.0	0.0		0.0	0.0	0.0	0.0
Total Delay		143.6	37.4			54.6	72.0		96.8	52.5	8.2	82.9
LOS		F	D			D	E		F	D	A	F
Approach Delay			53.5				68.5			59.3		
Approach LOS			D				E			E		
Queue Length 50th (ft)		~171	265			102	~459		~223	372	8	94
Queue Length 95th (ft)		#321	326			146	#595		#408	#504	50	#243
Internal Link Dist (ft)			567				779			590		
Turn Bay Length (ft)		140				170			200		130	145
Base Capacity (vph)		190	1534			474	1128		330	1109	567	208
Starvation Cap Reductn		0	0			0	0		0	0	0	0
Spillback Cap Reductn		0	0			0	0		0	0	0	0
Storage Cap Reductn		0	0			0	0		0	0	0	0
Reduced v/c Ratio		1.11	0.77			0.62	1.03		1.06	0.94	0.21	0.97

#### Intersection Summary

Area Type:	Other
Cycle Length:	110
Actuated Cycle Length:	110
Control Type:	Actuated-Uncoordinated
Maximum v/c Ratio:	1.11
Intersection Signal Delay:	62.3
Intersection LOS:	E

Lanes, Volumes, Timings  
 3: Lemon Street & Orangethorpe Avenue

05/27/2021



Lane Group	SBT	SBR
Lane Configurations	↑↑	↑
Traffic Volume (vph)	794	142
Future Volume (vph)	794	142
Ideal Flow (vphpl)	1900	1900
Storage Length (ft)		175
Storage Lanes		1
Taper Length (ft)		
Satd. Flow (prot)	3539	1583
Flt Permitted		
Satd. Flow (perm)	3539	1583
Right Turn on Red		Yes
Satd. Flow (RTOR)		149
Link Speed (mph)	40	
Link Distance (ft)	291	
Travel Time (s)	5.0	
Peak Hour Factor	0.92	0.92
Shared Lane Traffic (%)		
Lane Group Flow (vph)	863	154
Turn Type	NA	Perm
Protected Phases	6	
Permitted Phases		6
Total Split (s)	31.0	31.0
Total Lost Time (s)	4.5	4.5
Act Effct Green (s)	26.5	26.5
Actuated g/C Ratio	0.24	0.24
v/c Ratio	1.01	0.31
Control Delay	76.0	7.9
Queue Delay	0.0	0.0
Total Delay	76.0	7.9
LOS	E	A
Approach Delay	68.5	
Approach LOS	E	
Queue Length 50th (ft)	~328	3
Queue Length 95th (ft)	#464	54
Internal Link Dist (ft)	211	
Turn Bay Length (ft)		175
Base Capacity (vph)	852	494
Starvation Cap Reductn	0	0
Spillback Cap Reductn	0	0
Storage Cap Reductn	0	0
Reduced v/c Ratio	1.01	0.31
<b>Intersection Summary</b>		



Lanes, Volumes, Timings

3: Lemon Street & Orangethorpe Avenue

05/27/2021

Intersection Capacity Utilization 97.6%

ICU Level of Service F

Analysis Period (min) 15

~ Volume exceeds capacity, queue is theoretically infinite.

Queue shown is maximum after two cycles.

# 95th percentile volume exceeds capacity, queue may be longer.





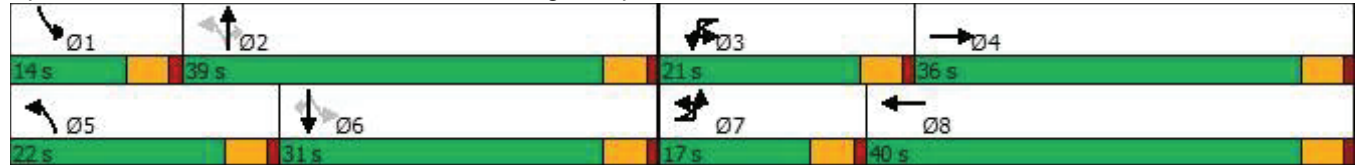















Queue shown is maximum after two cycles.

Splits and Phases: 3: Lemon Street & Orangethorpe Avenue



Lanes, Volumes, Timings  
4: Lemon Street & South Project Access

05/27/2021

												
Lane Group	EBL	EBT	EBR	WBL	WBT	WBR	NBL	NBT	NBR	SBL	SBT	SBR
Lane Configurations												
Traffic Volume (vph)	11	2	73	26	1	26	13	1282	41	16	1020	19
Future Volume (vph)	11	2	73	26	1	26	13	1282	41	16	1020	19
Ideal Flow (vphpl)	1900	1900	1900	1900	1900	1900	1800	1900	1900	1800	1900	1900
Storage Length (ft)	0		0	0		0	20		0	50		0
Storage Lanes	0		0	0		1	1		0	1		0
Taper Length (ft)	25			25			25			25		
Satd. Flow (prot)	0	1639	0	0	1777	1583	1676	3522	0	1676	3529	0
Flt Permitted		0.994			0.954		0.950			0.950		
Satd. Flow (perm)	0	1639	0	0	1777	1583	1676	3522	0	1676	3529	0
Link Speed (mph)		25			30			40			40	
Link Distance (ft)		267			71			291			254	
Travel Time (s)		7.3			1.6			5.0			4.3	
Peak Hour Factor	0.92	0.92	0.92	0.92	0.92	0.92	0.92	0.92	0.92	0.92	0.92	0.92
Shared Lane Traffic (%)												
Lane Group Flow (vph)	0	93	0	0	29	28	14	1438	0	17	1130	0
Sign Control		Stop			Stop			Free			Free	
<b>Intersection Summary</b>												
Area Type:	Other											
Control Type:	Unsignalized											
Intersection Capacity Utilization	55.3%						ICU Level of Service B					
Analysis Period (min)	15											

HCM 6th TWSC  
4: Lemon Street & South Project Access

05/27/2021

Intersection

Int Delay, s/veh 7.5

Movement	EBL	EBT	EBR	WBL	WBT	WBR	NBL	NBT	NBR	SBL	SBT	SBR
Lane Configurations		↕			↕	↕	↕	↕		↕	↕	
Traffic Vol, veh/h	11	2	73	26	1	26	13	1282	41	16	1020	19
Future Vol, veh/h	11	2	73	26	1	26	13	1282	41	16	1020	19
Conflicting Peds, #/hr	0	0	0	0	0	0	0	0	0	0	0	0
Sign Control	Stop	Stop	Stop	Stop	Stop	Stop	Free	Free	Free	Free	Free	Free
RT Channelized	-	-	None	-	-	None	-	-	None	-	-	None
Storage Length	-	-	-	-	-	0	20	-	-	50	-	-
Veh in Median Storage, #	0	-	-	0	-	-	0	-	-	0	-	-
Grade, %	-	0	-	-	0	-	-	0	-	-	0	-
Peak Hour Factor	92	92	92	92	92	92	92	92	92	92	92	92
Heavy Vehicles, %	2	2	2	2	2	2	2	2	2	2	2	2
Mvmt Flow	12	2	79	28	1	28	14	1393	45	17	1109	21

Major/Minor	Minor2	Minor1	Major1	Major2
Conflicting Flow All	1879	2620	565	2034
Stage 1	1154	1154	-	1444
Stage 2	725	1466	-	590
Critical Hdwy	7.54	6.54	6.94	7.54
Critical Hdwy Stg 1	6.54	5.54	-	6.54
Critical Hdwy Stg 2	6.54	5.54	-	6.54
Follow-up Hdwy	3.52	4.02	3.32	3.52
Pot Cap-1 Maneuver	44	24	468	33
Stage 1	210	270	-	139
Stage 2	383	191	-	461
Platoon blocked, %				
Mov Cap-1 Maneuver	37	23	468	~ 24
Mov Cap-2 Maneuver	37	23	-	~ 24
Stage 1	205	260	-	136
Stage 2	344	187	-	366

Approach	EB	WB	NB	SB
HCM Control Delay, s	5.7	260.7	0.1	0.2
HCM LOS	F	F		

Minor Lane/Major Mvmt	NBL	NBT	NBR	EBLn	WBLn	WBLn2	SBL	SBT	SBR
Capacity (veh/h)	614	-	-	159	24	371	468	-	-
HCM Lane V/C Ratio	0.023	-	-	0.588	1.223	0.076	0.037	-	-
HCM Control Delay (s)	11	-	-	55.3	496.8	15.5	13	-	-
HCM Lane LOS	B	-	-	F	F	C	B	-	-
HCM 95th %tile Q(veh)	0.1	-	-	3.1	3.7	0.2	0.1	-	-

Notes

~: Volume exceeds capacity    \$: Delay exceeds 300s    +: Computation Not Defined    \*: All major volume in platoon

Lanes, Volumes, Timings

5: Lemon Street & North Project Access/Liberty Avenue

05/27/2021



Lane Group	EBL	EBT	EBR	WBL	WBT	WBR	NBL	NBT	NBR	SBL	SBT	SBR
Lane Configurations		↕	↗		↔		↖	↕↔		↖	↕↔	
Traffic Volume (vph)	60	0	91	35	1	22	123	1181	11	1	914	70
Future Volume (vph)	60	0	91	35	1	22	123	1181	11	1	914	70
Ideal Flow (vphpl)	1900	1900	1900	1900	1900	1900	1800	1900	1900	1800	1900	1900
Storage Length (ft)	0		0	0		0	50		0	50		0
Storage Lanes	0		1	0		0	1		0	1		0
Taper Length (ft)	25			25			25			25		
Satd. Flow (prot)	0	1770	1583	0	1716	0	1676	3536	0	1676	3500	0
Flt Permitted		0.950			0.971		0.950			0.950		
Satd. Flow (perm)	0	1770	1583	0	1716	0	1676	3536	0	1676	3500	0
Link Speed (mph)		30			25			40			40	
Link Distance (ft)		333			454			254			394	
Travel Time (s)		7.6			12.4			4.3			6.7	
Peak Hour Factor	0.92	0.92	0.92	0.92	0.92	0.92	0.92	0.92	0.92	0.92	0.92	0.92
Shared Lane Traffic (%)												
Lane Group Flow (vph)	0	65	99	0	63	0	134	1296	0	1	1069	0
Sign Control		Stop			Stop			Free			Free	

Intersection Summary

Area Type:	Other
Control Type:	Unsignalized
Intersection Capacity Utilization	56.3%
	ICU Level of Service B
Analysis Period (min)	15

HCM 6th TWSC  
 5: Lemon Street & North Project Access/Liberty Avenue

05/27/2021

Intersection

Int Delay, s/veh 37.6

Movement	EBL	EBT	EBR	WBL	WBT	WBR	NBL	NBT	NBR	SBL	SBT	SBR
Lane Configurations		↑	↑		↑		↑	↑		↑	↑	
Traffic Vol, veh/h	60	0	91	35	1	22	123	1181	11	1	914	70
Future Vol, veh/h	60	0	91	35	1	22	123	1181	11	1	914	70
Conflicting Peds, #/hr	0	0	0	0	0	0	0	0	0	0	0	0
Sign Control	Stop	Stop	Stop	Stop	Stop	Stop	Free	Free	Free	Free	Free	Free
RT Channelized	-	-	None	-	-	None	-	-	None	-	-	None
Storage Length	-	-	0	-	-	-	50	-	-	50	-	-
Veh in Median Storage, #	0	-	-	0	-	-	-	0	-	-	0	-
Grade, %	-	0	-	-	0	-	-	0	-	-	0	-
Peak Hour Factor	92	92	92	92	92	92	92	92	92	92	92	92
Heavy Vehicles, %	2	2	2	2	2	2	2	2	2	2	2	2
Mvmt Flow	65	0	99	38	1	24	134	1284	12	1	993	76

Major/Minor	Minor2	Minor1	Major1	Major2								
Conflicting Flow	All1944	2597	535	2057	2629	648	1069	0	0	1296	0	0
Stage 1	1033	1033	-	1558	1558	-	-	-	-	-	-	-
Stage 2	911	1564	-	499	1071	-	-	-	-	-	-	-
Critical Hdwy	7.54	6.54	6.94	7.54	6.54	6.94	4.14	-	-	4.14	-	-
Critical Hdwy Stg 1	6.54	5.54	-	6.54	5.54	-	-	-	-	-	-	-
Critical Hdwy Stg 2	6.54	5.54	-	6.54	5.54	-	-	-	-	-	-	-
Follow-up Hdwy	3.52	4.02	3.32	3.52	4.02	3.32	2.22	-	-	2.22	-	-
Pot Cap-1 Maneuver	39	25	490	~ 32	23	413	648	-	-	531	-	-
Stage 1	249	308	-	118	172	-	-	-	-	-	-	-
Stage 2	295	171	-	522	295	-	-	-	-	-	-	-
Platoon blocked, %								-	-	-	-	-
Mov Cap-1 Maneuver	29	20	490	~ 21	18	413	648	-	-	531	-	-
Mov Cap-2 Maneuver	29	20	-	~ 21	18	-	-	-	-	-	-	-
Stage 1	197	307	-	94	136	-	-	-	-	-	-	-
Stage 2	219	136	-	416	294	-	-	-	-	-	-	-

Approach	EB	WB	NB	SB
HCM Control Delay, s	35.2	\$ 687.4	1.1	0
HCM LOS	F	F		

Minor Lane/Major Mvmt	NBL	NBT	NBR	EBLn	EBLn1	WBLn	SBL	SBT	SBR
Capacity (veh/h)	648	-	-	29	490	33	531	-	-
HCM Lane V/C Ratio	0.206	-	-	2.249	0.202	1.91	0.002	-	-
HCM Control Delay (s)	12	-	-	\$ 862.4	14.2	\$ 687.4	11.8	-	-
HCM Lane LOS	B	-	-	F	B	F	B	-	-
HCM 95th %tile Q(veh)	0.8	-	-	7.7	0.7	7.1	0	-	-

Notes  
 ~: Volume exceeds capacity    \$: Delay exceeds 300s    +: Computation Not Defined    \*: All major volume in platoon

Lanes, Volumes, Timings  
1: Harbor Boulevard & Orangethorpe Avenue

05/28/2021



Lane Group	EBL	EBT	EBR	WBU	WBL	WBT	WBR	NBL	NBT	NBR	SBU	SBL
Lane Configurations	↔	↑↑↑	↗		↖	↑↑↑	↗	↖	↑↑	↗		↖
Traffic Volume (vph)	188	832	204	3	162	490	169	112	1209	192	5	193
Future Volume (vph)	188	832	204	3	162	490	169	112	1209	192	5	193
Ideal Flow (vphpl)	1800	1900	1900	1800	1800	1900	1900	1750	1900	1900	1750	1750
Storage Length (ft)	200		130		240		140	120		250		270
Storage Lanes	1		1		1		1	2		0		2
Taper Length (ft)	90				60			90				100
Satd. Flow (prot)	1676	5085	1583	0	1676	5085	1583	3162	3539	1583	0	3162
Flt Permitted	0.950				0.950			0.950				0.950
Satd. Flow (perm)	1676	5085	1583	0	1676	5085	1583	3162	3539	1583	0	3162
Right Turn on Red			Yes				Yes			Yes		
Satd. Flow (RTOR)			204				184			201		
Link Speed (mph)		40				40			40			
Link Distance (ft)		787				701			655			
Travel Time (s)		13.4				11.9			11.2			
Peak Hour Factor	0.92	0.92	0.92	0.92	0.92	0.92	0.92	0.92	0.92	0.92	0.92	0.92
Shared Lane Traffic (%)												
Lane Group Flow (vph)	204	904	222	0	179	533	184	122	1314	209	0	215
Turn Type	Prot	NA	Perm	Prot	Prot	NA	Perm	Prot	NA	Perm	Prot	Prot
Protected Phases	7	4		3	3	8		5	2		1	1
Permitted Phases			4				8			2		
Total Split (s)	18.0	21.0	21.0	18.0	18.0	21.0	21.0	16.0	35.0	35.0	16.0	16.0
Total Lost Time (s)	4.5	4.5	4.5		4.5	4.5	4.5	4.5	4.5	4.5		4.5
Act Effct Green (s)	12.9	16.5	16.5		12.5	16.1	16.1	8.7	30.6	30.6		10.4
Actuated g/C Ratio	0.15	0.19	0.19		0.14	0.18	0.18	0.10	0.35	0.35		0.12
v/c Ratio	0.83	0.95	0.48		0.76	0.57	0.42	0.39	1.07	0.31		0.58
Control Delay	64.9	55.6	10.1		57.5	35.9	8.4	40.9	76.3	5.0		43.5
Queue Delay	0.0	0.0	0.0		0.0	0.0	0.0	0.0	0.0	0.0		0.0
Total Delay	64.9	55.6	10.1		57.5	35.9	8.4	40.9	76.3	5.0		43.5
LOS	E	E	B		E	D	A	D	E	A		D
Approach Delay		49.4				34.5			64.7			
Approach LOS		D				C			E			
Queue Length 50th (ft)	114	188	9		98	102	0	34	~448	3		59
Queue Length 95th (ft)	#230	#275	70		#192	138	55	59	#580	49		95
Internal Link Dist (ft)		707				621			575			
Turn Bay Length (ft)	200		130		240		140	120		250		270
Base Capacity (vph)	257	955	462		257	955	446	414	1228	680		414
Starvation Cap Reductn	0	0	0		0	0	0	0	0	0		0
Spillback Cap Reductn	0	0	0		0	0	0	0	0	0		0
Storage Cap Reductn	0	0	0		0	0	0	0	0	0		0
Reduced v/c Ratio	0.79	0.95	0.48		0.70	0.56	0.41	0.29	1.07	0.31		0.52

Intersection Summary

Area Type:	Other
Cycle Length:	90
Actuated Cycle Length:	88
Control Type:	Actuated-Uncoordinated
Maximum v/c Ratio:	1.07
Intersection Signal Delay:	46.7
Intersection LOS:	D



Lanes, Volumes, Timings  
 1: Harbor Boulevard & Orangethorpe Avenue

05/28/2021



Lane Group	SBT	SBR
Lane Configurations	↑↑↑	
Traffic Volume (vph)	1517	128
Future Volume (vph)	1517	128
Ideal Flow (vphpl)	1900	1900
Storage Length (ft)		160
Storage Lanes		0
Taper Length (ft)		
Satd. Flow (prot)	5024	0
Flt Permitted		
Satd. Flow (perm)	5024	0
Right Turn on Red		Yes
Satd. Flow (RTOR)	16	
Link Speed (mph)	40	
Link Distance (ft)	935	
Travel Time (s)	15.9	
Peak Hour Factor	0.92	0.92
Shared Lane Traffic (%)		
Lane Group Flow (vph)	1788	0
Turn Type	NA	
Protected Phases	6	
Permitted Phases		
Total Split (s)	35.0	
Total Lost Time (s)	4.5	
Act Effct Green (s)	34.5	
Actuated g/C Ratio	0.39	
v/c Ratio	0.90	
Control Delay	34.5	
Queue Delay	0.0	
Total Delay	34.5	
LOS	C	
Approach Delay	35.5	
Approach LOS	D	
Queue Length 50th (ft)	355	
Queue Length 95th (ft)	#500	
Internal Link Dist (ft)	855	
Turn Bay Length (ft)		
Base Capacity (vph)	1980	
Starvation Cap Reductn	0	
Spillback Cap Reductn	0	
Storage Cap Reductn	0	
Reduced v/c Ratio	0.90	

Intersection Summary

Lanes, Volumes, Timings  
 1: Harbor Boulevard & Orangethorpe Avenue

05/28/2021

Intersection Capacity Utilization 80.3%      ICU Level of Service D  
 Analysis Period (min) 15









~ Volume exceeds capacity, queue is theoretically infinite.

Queue shown is maximum after two cycles.

# 95th percentile volume exceeds capacity, queue may be longer.

Queue shown is maximum after two cycles.

Splits and Phases: 1: Harbor Boulevard & Orangethorpe Avenue

 Ø1	 Ø2	 Ø3	 Ø4
16 s	35 s	18 s	21 s
 Ø5	 Ø6	 Ø7	 Ø8
16 s	35 s	18 s	21 s

Lanes, Volumes, Timings  
2: Pomona Avenue & Orangethorpe Avenue

05/28/2021



Lane Group	EBU	EBL	EBT	EBR	WBU	WBL	WBT	WBR	NBL	NBT	NBR	SBL
Lane Configurations		↔	↑↑↑				↔	↑↑	↗	↖	↔	↗
Traffic Volume (vph)	2	104	1189	51	20	23	704	92	56	18	28	90
Future Volume (vph)	2	104	1189	51	20	23	704	92	56	18	28	90
Ideal Flow (vphpl)	1800	1800	1900	1900	1800	1800	1900	1900	1800	1900	1900	1800
Storage Length (ft)		140		0		150		70	95		0	70
Storage Lanes		1		0		1		1	1		0	1
Taper Length (ft)		60				70			30			60
Satd. Flow (prot)	0	1676	5055	0	0	1676	3539	1583	1676	1695	0	1676
Flt Permitted		0.362				0.183			0.714			0.724
Satd. Flow (perm)	0	639	5055	0	0	323	3539	1583	1260	1695	0	1278
Right Turn on Red				Yes				Yes			Yes	
Satd. Flow (RTOR)			27					100		30		
Link Speed (mph)			40				40			25		
Link Distance (ft)			701				647			214		
Travel Time (s)			11.9				11.0			5.8		
Peak Hour Factor	0.92	0.92	0.92	0.92	0.92	0.92	0.92	0.92	0.92	0.92	0.92	0.92
Shared Lane Traffic (%)												
Lane Group Flow (vph)	0	115	1347	0	0	47	765	100	61	50	0	98
Turn Type	Perm	Perm	NA		Perm	Perm	NA	Perm	Perm	NA		Perm
Protected Phases			4				8			2		
Permitted Phases	4	4			8	8		8	2			6
Total Split (s)	33.0	33.0	33.0		33.0	33.0	33.0	33.0	12.0	12.0		12.0
Total Lost Time (s)		4.5	4.5				4.5	4.5	4.5	4.5		4.5
Act Effct Green (s)		25.6	25.6				25.6	25.6	25.6	7.0	7.0	7.0
Actuated g/C Ratio		0.67	0.67				0.67	0.67	0.67	0.18	0.18	0.18
v/c Ratio		0.27	0.40				0.22	0.32	0.09	0.26	0.15	0.42
Control Delay		6.0	4.3				6.9	4.2	1.2	18.4	10.6	21.6
Queue Delay		0.0	0.0				0.0	0.0	0.0	0.0	0.0	0.0
Total Delay		6.0	4.3				6.9	4.2	1.2	18.4	10.6	21.6
LOS		A	A				A	A	A	B	B	C
Approach Delay			4.4				4.0			14.9		
Approach LOS			A				A			B		
Queue Length 50th (ft)		10	47				4	37	0	10	3	17
Queue Length 95th (ft)		29	67				17	57	10	40	25	#61
Internal Link Dist (ft)			621					567		134		
Turn Bay Length (ft)		140					150		70	95		70
Base Capacity (vph)		487	3864				246	2701	1232	253	364	256
Starvation Cap Reductn		0	0				0	0	0	0	0	0
Spillback Cap Reductn		0	0				0	0	0	0	0	0
Storage Cap Reductn		0	0				0	0	0	0	0	0
Reduced v/c Ratio		0.24	0.35				0.19	0.28	0.08	0.24	0.14	0.38

Intersection Summary

Area Type:	Other
Cycle Length:	45
Actuated Cycle Length:	38.1
Control Type:	Actuated-Uncoordinated
Maximum v/c Ratio:	0.42
Intersection Signal Delay:	5.5
Intersection LOS:	A

Lanes, Volumes, Timings  
 2: Pomona Avenue & Orangethorpe Avenue

05/28/2021



Lane Group	SBT	SBR
Lane Configurations	7	91
Traffic Volume (vph)	7	91
Future Volume (vph)	7	91
Ideal Flow (vphpl)	1900	1900
Storage Length (ft)		0
Storage Lanes		0
Taper Length (ft)		
Satd. Flow (prot)	1604	0
Flt Permitted		
Satd. Flow (perm)	1604	0
Right Turn on Red		Yes
Satd. Flow (RTOR)	99	
Link Speed (mph)	25	
Link Distance (ft)	398	
Travel Time (s)	10.9	
Peak Hour Factor	0.92	0.92
Shared Lane Traffic (%)		
Lane Group Flow (vph)	107	0
Turn Type	NA	
Protected Phases	6	
Permitted Phases		
Total Split (s)	12.0	
Total Lost Time (s)	4.5	
Act Effct Green (s)	7.0	
Actuated g/C Ratio	0.18	
v/c Ratio	0.29	
Control Delay	7.6	
Queue Delay	0.0	
Total Delay	7.6	
LOS	A	
Approach Delay	14.3	
Approach LOS	B	
Queue Length 50th (ft)	1	
Queue Length 95th (ft)	32	
Internal Link Dist (ft)	318	
Turn Bay Length (ft)		
Base Capacity (vph)	401	
Starvation Cap Reductn	0	
Spillback Cap Reductn	0	
Storage Cap Reductn	0	
Reduced v/c Ratio	0.27	
Intersection Summary		

Lanes, Volumes, Timings  
2: Pomona Avenue & Orangethorpe Avenue

05/28/2021

Intersection Capacity Utilization 51.5% ICU Level of Service A

Analysis Period (min) 15

# 95th percentile volume exceeds capacity, queue may be longer.

Queue shown is maximum after two cycles.

Splits and Phases: 2: Pomona Avenue & Orangethorpe Avenue



Lanes, Volumes, Timings  
3: Lemon Street & Orangethorpe Avenue

05/28/2021



Lane Group	EBU	EBL	EBT	EBR	WBL	WBT	WBR	NBL	NBT	NBR	SBL	SBT
Lane Configurations		↔	↑↑↑		↔	↑↑		↔	↑↑	↔	↔	↑↑
Traffic Volume (vph)	2	84	1044	225	149	576	113	247	758	223	216	849
Future Volume (vph)	2	84	1044	225	149	576	113	247	758	223	216	849
Ideal Flow (vphpl)	1800	1800	1900	1900	1750	1900	1900	1800	1900	1900	1800	1900
Storage Length (ft)		140		0	170		0	200		130	145	
Storage Lanes		1		0	2		0	1		1	1	
Taper Length (ft)		115			120			90			105	
Satd. Flow (prot)	0	1676	4948	0	3162	3451	0	1676	3539	1583	1676	3539
Flt Permitted		0.950			0.950			0.161			0.163	
Satd. Flow (perm)	0	1676	4948	0	3162	3451	0	284	3539	1583	288	3539
Right Turn on Red				Yes			Yes			Yes		
Satd. Flow (RTOR)			52			25				190		
Link Speed (mph)			40			40			40			40
Link Distance (ft)			647			477			670			291
Travel Time (s)			11.0			8.1			11.4			5.0
Peak Hour Factor	0.92	0.92	0.92	0.92	0.92	0.92	0.92	0.92	0.92	0.92	0.92	0.92
Shared Lane Traffic (%)												
Lane Group Flow (vph)	0	93	1380	0	162	749	0	268	824	242	235	923
Turn Type	Prot	Prot	NA		Prot	NA		pm+pt	NA	Perm	pm+pt	NA
Protected Phases	7	7	4		3	8		5	2		1	6
Permitted Phases								2		2		6
Total Split (s)	17.0	17.0	29.0		16.0	28.0		16.0	29.0	29.0	16.0	29.0
Total Lost Time (s)		4.5	4.5		4.5	4.5		4.5	4.5	4.5	4.5	4.5
Act Effct Green (s)		9.8	24.5		9.6	26.5		36.4	24.9	24.9	35.7	24.5
Actuated g/C Ratio		0.11	0.28		0.11	0.30		0.41	0.28	0.28	0.41	0.28
v/c Ratio		0.50	0.98		0.47	0.71		0.90	0.83	0.42	0.80	0.94
Control Delay		46.0	50.4		41.6	32.4		54.2	38.4	9.4	40.8	49.5
Queue Delay		0.0	0.0		0.0	0.0		0.0	0.0	0.0	0.0	0.0
Total Delay		46.0	50.4		41.6	32.4		54.2	38.4	9.4	40.8	49.5
LOS		D	D		D	C		D	D	A	D	D
Approach Delay			50.1			34.0			36.3			44.6
Approach LOS			D			C			D			D
Queue Length 50th (ft)		49	269		44	196		99	226	22	79	264
Queue Length 95th (ft)		96	#386		75	#278		#251	#333	83	#202	#398
Internal Link Dist (ft)			567			397			590			211
Turn Bay Length (ft)		140			170			200		130	145	
Base Capacity (vph)		238	1414		413	1053		299	998	583	299	984
Starvation Cap Reductn		0	0		0	0		0	0	0	0	0
Spillback Cap Reductn		0	0		0	0		0	0	0	0	0
Storage Cap Reductn		0	0		0	0		0	0	0	0	0
Reduced v/c Ratio		0.39	0.98		0.39	0.71		0.90	0.83	0.42	0.79	0.94

Intersection Summary

Area Type:	Other
Cycle Length:	90
Actuated Cycle Length:	88.1
Control Type:	Actuated-Uncoordinated
Maximum v/c Ratio:	0.98
Intersection Signal Delay:	42.1
Intersection LOS:	D



Lanes, Volumes, Timings  
 3: Lemon Street & Orangethorpe Avenue

05/28/2021

Lane Group	SBR
Lane Configurations	
Traffic Volume (vph)	81
Future Volume (vph)	81
Ideal Flow (vphpl)	1900
Storage Length (ft)	175
Storage Lanes	1
Taper Length (ft)	
Satd. Flow (prot)	1583
Flt Permitted	
Satd. Flow (perm)	1583
Right Turn on Red	Yes
Satd. Flow (RTOR)	127
Link Speed (mph)	
Link Distance (ft)	
Travel Time (s)	
Peak Hour Factor	0.92
Shared Lane Traffic (%)	
Lane Group Flow (vph)	88
Turn Type	Perm
Protected Phases	
Permitted Phases	6
Total Split (s)	29.0
Total Lost Time (s)	4.5
Act Effct Green (s)	24.5
Actuated g/C Ratio	0.28
v/c Ratio	0.17
Control Delay	2.7
Queue Delay	0.0
Total Delay	2.7
LOS	A
Approach Delay	
Approach LOS	
Queue Length 50th (ft)	0
Queue Length 95th (ft)	17
Internal Link Dist (ft)	
Turn Bay Length (ft)	175
Base Capacity (vph)	532
Starvation Cap Reductn	0
Spillback Cap Reductn	0
Storage Cap Reductn	0
Reduced v/c Ratio	0.17
<b>Intersection Summary</b>	

Lanes, Volumes, Timings  
 3: Lemon Street & Orangethorpe Avenue

05/28/2021

Intersection Capacity Utilization 82.7% ICU Level of Service E

Analysis Period (min) 15

# 95th percentile volume exceeds capacity, queue may be longer.





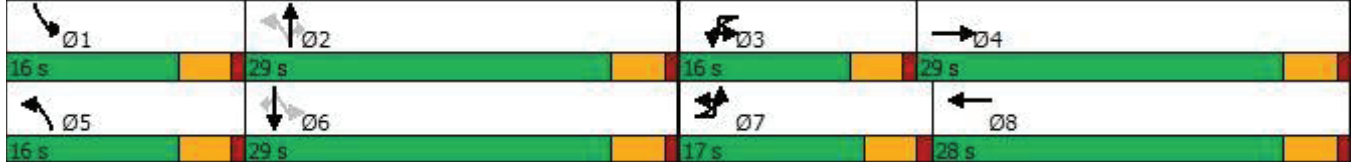













Queue shown is maximum after two cycles.

Splits and Phases: 3: Lemon Street & Orangethorpe Avenue



Lanes, Volumes, Timings  
 4: Lemon Street & South Project Access

05/28/2021

												
Lane Group	EBL	EBT	EBR	WBL	WBT	WBR	NBL	NBT	NBR	SBL	SBT	SBR
Lane Configurations								 			 	
Traffic Volume (vph)	0	0	53	0	0	4	0	953	4	0	1111	29
Future Volume (vph)	0	0	53	0	0	4	0	953	4	0	1111	29
Ideal Flow (vphpl)	1900	1900	1900	1900	1900	1900	1800	1900	1900	1800	1900	1900
Storage Length (ft)	0		0	0		0	20		0	50		0
Storage Lanes	0		1	0		1	0		0	0		0
Taper Length (ft)	25			25			25			25		
Satd. Flow (prot)	0	0	1611	0	0	1611	0	3536	0	0	3525	0
Flt Permitted												
Satd. Flow (perm)	0	0	1611	0	0	1611	0	3536	0	0	3525	0
Link Speed (mph)		25			30			40			40	
Link Distance (ft)		267			71			291			254	
Travel Time (s)		7.3			1.6			5.0			4.3	
Peak Hour Factor	0.92	0.92	0.92	0.92	0.92	0.92	0.92	0.92	0.92	0.92	0.92	0.92
Shared Lane Traffic (%)												
Lane Group Flow (vph)	0	0	58	0	0	4	0	1040	0	0	1240	0
Sign Control		Stop			Stop			Free			Free	
<b>Intersection Summary</b>												
Area Type:	Other											
Control Type:	Unsignalized											
Intersection Capacity Utilization	41.6%			ICU Level of Service A								
Analysis Period (min)	15											

HCM 6th TWSC  
 4: Lemon Street & South Project Access

05/28/2021

Intersection

Int Delay, s/veh 0.4

Movement	EBL	EBT	EBR	WBL	WBT	WBR	NBL	NBT	NBR	SBL	SBT	SBR
Lane Configurations			↗			↗		↕			↕	
Traffic Vol, veh/h	0	0	53	0	0	4	0	953	4	0	1111	29
Future Vol, veh/h	0	0	53	0	0	4	0	953	4	0	1111	29
Conflicting Peds, #/hr	0	0	0	0	0	0	0	0	0	0	0	0
Sign Control	Stop	Stop	Stop	Stop	Stop	Stop	Free	Free	Free	Free	Free	Free
RT Channelized	-	-	None	-	-	None	-	-	None	-	-	None
Storage Length	-	-	0	-	-	0	-	-	-	-	-	-
Veh in Median Storage, #	0	-	-	0	-	-	0	-	-	0	-	-
Grade, %	-	0	-	-	0	-	-	0	-	-	0	-
Peak Hour Factor	92	92	92	92	92	92	92	92	92	92	92	92
Heavy Vehicles, %	2	2	2	2	2	2	2	2	2	2	2	2
Mvmt Flow	0	0	58	0	0	4	0	1036	4	0	1208	32

Major/Minor	Minor2	Minor1	Major1	Major2								
Conflicting Flow All	-	-	620	-	-	520	-	0	0	-	-	0
Stage 1	-	-	-	-	-	-	-	-	-	-	-	-
Stage 2	-	-	-	-	-	-	-	-	-	-	-	-
Critical Hdwy	-	-	6.94	-	-	6.94	-	-	-	-	-	-
Critical Hdwy Stg 1	-	-	-	-	-	-	-	-	-	-	-	-
Critical Hdwy Stg 2	-	-	-	-	-	-	-	-	-	-	-	-
Follow-up Hdwy	-	-	3.32	-	-	3.32	-	-	-	-	-	-
Pot Cap-1 Maneuver	0	0	431	0	0	501	0	-	-	0	-	-
Stage 1	0	0	-	0	0	-	0	-	-	0	-	-
Stage 2	0	0	-	0	0	-	0	-	-	0	-	-
Platoon blocked, %								-	-	-	-	-
Mov Cap-1 Maneuver	-	-	431	-	-	501	-	-	-	-	-	-
Mov Cap-2 Maneuver	-	-	-	-	-	-	-	-	-	-	-	-
Stage 1	-	-	-	-	-	-	-	-	-	-	-	-
Stage 2	-	-	-	-	-	-	-	-	-	-	-	-

Approach	EB	WB	NB	SB
HCM Control Delay, s	4.6	12.2	0	0
HCM LOS	B	B		

Minor Lane/Major Mvmt	NBT	NBR	EBLn	WBLn1	SBT	SBR
Capacity (veh/h)	-	-	431	501	-	-
HCM Lane V/C Ratio	-	-	0.134	0.009	-	-
HCM Control Delay (s)	-	-	14.6	12.2	-	-
HCM Lane LOS	-	-	B	B	-	-
HCM 95th %tile Q(veh)	-	-	0.5	0	-	-

Lanes, Volumes, Timings  
5: Lemon Street & North Project Access/Liberty Avenue

08/17/2021



Lane Group	EBL	EBT	EBR	WBL	WBT	WBR	NBL	NBT	NBR	SBL	SBT	SBR
Lane Configurations		↕	↗		↔		↖	↕↔		↖	↕↕	↗
Traffic Volume (vph)	36	0	75	52	2	12	33	799	95	29	1012	20
Future Volume (vph)	36	0	75	52	2	12	33	799	95	29	1012	20
Ideal Flow (vphpl)	1900	1900	1900	1900	1900	1900	1800	1900	1900	1800	1900	1900
Storage Length (ft)	0		0	0		0	50		0	50		0
Storage Lanes	0		1	0		0	1		0	1		1
Taper Length (ft)	25			25			25			25		
Satd. Flow (prot)	0	1770	1583	0	1749	0	1676	3483	0	1676	3539	1583
Flt Permitted		0.950			0.962		0.185			0.231		
Satd. Flow (perm)	0	1770	1583	0	1749	0	326	3483	0	408	3539	1583
Right Turn on Red			Yes			Yes			Yes			Yes
Satd. Flow (RTOR)			127		10			18				127
Link Speed (mph)		30			25			40			40	
Link Distance (ft)		333			454			254			394	
Travel Time (s)		7.6			12.4			4.3			6.7	
Peak Hour Factor	0.92	0.92	0.92	0.92	0.92	0.92	0.92	0.92	0.92	0.92	0.92	0.92
Shared Lane Traffic (%)												
Lane Group Flow (vph)	0	39	82	0	72	0	36	971	0	32	1100	22
Turn Type	Split	NA	Perm	Split	NA		pm+pt	NA		pm+pt	NA	Perm
Protected Phases	4	4		8	8		5	2		1	6	
Permitted Phases			4				2			6		6
Total Split (s)	18.0	18.0	18.0	18.0	18.0		10.0	44.0		10.0	44.0	44.0
Total Lost Time (s)		4.5	4.5		4.5		4.5	4.5		4.5	4.5	4.5
Act Effct Green (s)		7.7	7.7		8.5		35.4	35.6		35.4	35.6	35.6
Actuated g/C Ratio		0.13	0.13		0.15		0.61	0.62		0.61	0.62	0.62
v/c Ratio		0.16	0.25		0.27		0.10	0.45		0.08	0.50	0.02
Control Delay		31.9	4.6		28.3		7.7	11.6		7.6	12.5	0.1
Queue Delay		0.0	0.0		0.0		0.0	0.0		0.0	0.0	0.0
Total Delay		31.9	4.6		28.3		7.7	11.6		7.6	12.5	0.1
LOS		C	A		C		A	B		A	B	A
Approach Delay		13.4			28.3			11.5			12.1	
Approach LOS		B			C			B			B	
Queue Length 50th (ft)		12	0		19		6	107		5	131	0
Queue Length 95th (ft)		48	17		69		19	246		18	294	0
Internal Link Dist (ft)		253			374			174			314	
Turn Bay Length (ft)							50			50		
Base Capacity (vph)		476	519		478		347	2511		389	2546	1174
Starvation Cap Reductn		0	0		0		0	0		0	0	0
Spillback Cap Reductn		0	0		0		0	0		0	0	0
Storage Cap Reductn		0	0		0		0	0		0	0	0
Reduced v/c Ratio		0.08	0.16		0.15		0.10	0.39		0.08	0.43	0.02

Intersection Summary

Area Type:	Other
Cycle Length:	90
Actuated Cycle Length:	57.8
Control Type:	Actuated-Uncoordinated
Maximum v/c Ratio:	0.50
Intersection Signal Delay:	12.4
Intersection LOS:	B

Lanes, Volumes, Timings

5: Lemon Street & North Project Access/Liberty Avenue







08/17/2021

Intersection Capacity Utilization 48.0%

ICU Level of Service A

Analysis Period (min) 15

Splits and Phases: 5: Lemon Street & North Project Access/Liberty Avenue

 Ø1	 Ø2	 Ø4	 Ø8
10 s	44 s	18 s	18 s
 Ø5	 Ø6		
10 s	44 s		



# Lanes, Volumes, Timings

## 1: Harbor Boulevard & Orangethorpe Avenue

05/28/2021



Lane Group	EBU	EBL	EBT	EBR	WBU	WBL	WBT	WBR	NBU	NBL	NBT	NBR
Lane Configurations		↔	↑↑↑	↗		↔	↑↑↑	↗		↔	↑↑	↗
Traffic Volume (vph)	2	240	804	183	15	237	962	199	1	237	1248	237
Future Volume (vph)	2	240	804	183	15	237	962	199	1	237	1248	237
Ideal Flow (vphpl)	1800	1800	1900	1900	1800	1800	1900	1900	1750	1750	1900	1900
Storage Length (ft)		200		130		240		140		120		250
Storage Lanes		1		1		1		1		2		0
Taper Length (ft)		90				60				90		
Satd. Flow (prot)	0	1676	5085	1583	0	1676	5085	1583	0	3162	3539	1583
Flt Permitted		0.950				0.950				0.950		
Satd. Flow (perm)	0	1676	5085	1583	0	1676	5085	1583	0	3162	3539	1583
Right Turn on Red				Yes				Yes				Yes
Satd. Flow (RTOR)				155				155				203
Link Speed (mph)			40				40				40	
Link Distance (ft)			787				701				655	
Travel Time (s)			13.4				11.9				11.2	
Peak Hour Factor	0.92	0.92	0.92	0.92	0.92	0.92	0.92	0.92	0.92	0.92	0.92	0.92
Shared Lane Traffic (%)												
Lane Group Flow (vph)	0	263	874	199	0	274	1046	216	0	259	1357	258
Turn Type	Prot	Prot	NA	Perm	Prot	Prot	NA	Perm	Prot	Prot	NA	Perm
Protected Phases	7	7	4		3	3	8		5	5	2	
Permitted Phases				4				8				2
Total Split (s)	24.0	24.0	25.0	25.0	27.0	27.0	28.0	28.0	22.0	22.0	44.0	44.0
Total Lost Time (s)		4.5	4.5	4.5		4.5	4.5	4.5		4.5	4.5	4.5
Act Effct Green (s)		18.9	21.6	21.6		20.8	23.5	23.5		14.0	39.5	39.5
Actuated g/C Ratio		0.17	0.20	0.20		0.19	0.21	0.21		0.13	0.36	0.36
v/c Ratio		0.91	0.87	0.46		0.86	0.96	0.47		0.64	1.06	0.37
Control Delay		79.3	53.6	14.5		68.5	61.8	15.5		52.5	78.3	8.0
Queue Delay		0.0	0.0	0.0		0.0	0.0	0.0		0.0	0.0	0.0
Total Delay		79.3	53.6	14.5		68.5	61.8	15.5		52.5	78.3	8.0
LOS		E	D	B		E	E	B		D	E	A
Approach Delay			52.8				56.5				65.0	
Approach LOS			D				E				E	
Queue Length 50th (ft)		183	224	26		185	269	36		90	~559	26
Queue Length 95th (ft)		#332	#304	95		#318	#362	107		129	#696	85
Internal Link Dist (ft)			707				621				575	
Turn Bay Length (ft)		200		130		240		140		120		250
Base Capacity (vph)		299	1004	437		344	1092	462		506	1277	701
Starvation Cap Reductn		0	0	0		0	0	0		0	0	0
Spillback Cap Reductn		0	0	0		0	0	0		0	0	0
Storage Cap Reductn		0	0	0		0	0	0		0	0	0
Reduced v/c Ratio		0.88	0.87	0.46		0.80	0.96	0.47		0.51	1.06	0.37

### Intersection Summary

Area Type: Other

Cycle Length: 110

Actuated Cycle Length: 109.4

Control Type: Actuated-Uncoordinated

Maximum v/c Ratio: 1.06

Intersection Signal Delay: 57.6

Intersection LOS: E

Lanes, Volumes, Timings  
 1: Harbor Boulevard & Orangethorpe Avenue

05/28/2021



Lane Group	SBU	SBL	SBT	SBR
Lane Configurations				
Traffic Volume (vph)	13	203	1205	212
Future Volume (vph)	13	203	1205	212
Ideal Flow (vphpl)	1750	1750	1900	1900
Storage Length (ft)		270		160
Storage Lanes		2		0
Taper Length (ft)		100		
Satd. Flow (prot)	0	3162	4973	0
Flt Permitted		0.950		
Satd. Flow (perm)	0	3162	4973	0
Right Turn on Red				Yes
Satd. Flow (RTOR)			32	
Link Speed (mph)			40	
Link Distance (ft)			935	
Travel Time (s)			15.9	
Peak Hour Factor	0.92	0.92	0.92	0.92
Shared Lane Traffic (%)				
Lane Group Flow (vph)	0	235	1540	0
Turn Type	Prot	Prot	NA	
Protected Phases	1	1	6	
Permitted Phases				
Total Split (s)	14.0	14.0	36.0	
Total Lost Time (s)		4.5	4.5	
Act Effct Green (s)		9.5	35.0	
Actuated g/C Ratio		0.09	0.32	
v/c Ratio		0.86	0.96	
Control Delay		77.6	50.9	
Queue Delay		0.0	0.0	
Total Delay		77.6	50.9	
LOS		E	D	
Approach Delay			54.4	
Approach LOS			D	
Queue Length 50th (ft)		86	383	
Queue Length 95th (ft)		#155	#532	
Internal Link Dist (ft)			855	
Turn Bay Length (ft)		270		
Base Capacity (vph)		274	1610	
Starvation Cap Reductn		0	0	
Spillback Cap Reductn		0	0	
Storage Cap Reductn		0	0	
Reduced v/c Ratio		0.86	0.96	
<b>Intersection Summary</b>				

Lanes, Volumes, Timings  
 1: Harbor Boulevard & Orangethorpe Avenue

05/28/2021

Intersection Capacity Utilization 88.9%      ICU Level of Service E

Analysis Period (min) 15

~ Volume exceeds capacity, queue is theoretically infinite.

Queue shown is maximum after two cycles.

# 95th percentile volume exceeds capacity, queue may be longer.

Queue shown is maximum after two cycles.

Splits and Phases: 1: Harbor Boulevard & Orangethorpe Avenue

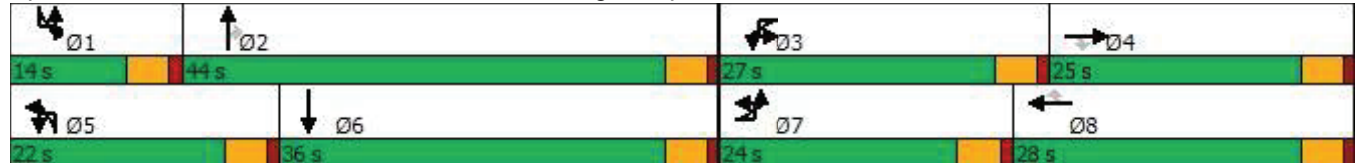

Lanes, Volumes, Timings  
 2: Pomona Avenue & Orangethorpe Avenue

05/28/2021



Lane Group	EBU	EBL	EBT	EBR	WBU	WBL	WBT	WBR	NBL	NBT	NBR	SBL
Lane Configurations		↔	↑↑↑				↔	↑↑	↔	↔	↔	↔
Traffic Volume (vph)	5	180	829	82	11	51	952	168	90	39	77	152
Future Volume (vph)	5	180	829	82	11	51	952	168	90	39	77	152
Ideal Flow (vphpl)	1800	1800	1900	1900	1800	1800	1900	1900	1800	1900	1900	1800
Storage Length (ft)		140		0		150		70	95		0	70
Storage Lanes		1		0		1		1	1		0	1
Taper Length (ft)		60				70			30			60
Satd. Flow (prot)	0	1676	5019	0	0	1676	3539	1583	1676	1676	0	1676
Flt Permitted		0.243				0.275			0.658			0.676
Satd. Flow (perm)	0	429	5019	0	0	485	3539	1583	1161	1676	0	1193
Right Turn on Red				Yes				Yes			Yes	
Satd. Flow (RTOR)			60					183		84		
Link Speed (mph)			40				40			25		
Link Distance (ft)			701				647			214		
Travel Time (s)			11.9				11.0			5.8		
Peak Hour Factor	0.92	0.92	0.92	0.92	0.92	0.92	0.92	0.92	0.92	0.92	0.92	0.92
Shared Lane Traffic (%)												
Lane Group Flow (vph)	0	201	990	0	0	67	1035	183	98	126	0	165
Turn Type	Perm	Perm	NA		Perm	Perm	NA	Perm	Perm	NA		Perm
Protected Phases			4				8			2		
Permitted Phases	4	4			8	8		8	2			6
Total Split (s)	40.0	40.0	40.0		40.0	40.0	40.0	40.0	15.0	15.0		15.0
Total Lost Time (s)		4.5	4.5			4.5	4.5	4.5	4.5	4.5		4.5
Act Effct Green (s)		30.6	30.6			30.6	30.6	30.6	9.9	9.9		9.9
Actuated g/C Ratio		0.62	0.62			0.62	0.62	0.62	0.20	0.20		0.20
v/c Ratio		0.76	0.32			0.22	0.47	0.17	0.43	0.32		0.70
Control Delay		30.4	4.5			6.4	5.9	1.2	25.5	11.2		39.4
Queue Delay		0.0	0.0			0.0	0.0	0.0	0.0	0.0		0.0
Total Delay		30.4	4.5			6.4	5.9	1.2	25.5	11.2		39.4
LOS		C	A			A	A	A	C	B		D
Approach Delay			8.9				5.3			17.4		
Approach LOS			A				A			B		
Queue Length 50th (ft)		36	39			7	72	0	27	11		48
Queue Length 95th (ft)		#151	54			22	103	15	67	49		#133
Internal Link Dist (ft)			621				567			134		
Turn Bay Length (ft)		140				150		70	95			70
Base Capacity (vph)		311	3665			352	2573	1201	249	426		256
Starvation Cap Reductn		0	0			0	0	0	0	0		0
Spillback Cap Reductn		0	0			0	0	0	0	0		0
Storage Cap Reductn		0	0			0	0	0	0	0		0
Reduced v/c Ratio		0.65	0.27			0.19	0.40	0.15	0.39	0.30		0.64

**Intersection Summary**  
 Area Type: Other  
 Cycle Length: 55  
 Actuated Cycle Length: 49.6  
 Control Type: Actuated-Uncoordinated  
 Maximum v/c Ratio: 0.76  
 Intersection Signal Delay: 9.7  
 Intersection LOS: A

Lanes, Volumes, Timings  
 2: Pomona Avenue & Orangethorpe Avenue

05/28/2021



Lane Group	SBT	SBR
Lane Configurations		
Traffic Volume (vph)	36	108
Future Volume (vph)	36	108
Ideal Flow (vphpl)	1900	1900
Storage Length (ft)		0
Storage Lanes		0
Taper Length (ft)		
Satd. Flow (prot)	1652	0
Flt Permitted		
Satd. Flow (perm)	1652	0
Right Turn on Red		Yes
Satd. Flow (RTOR)	117	
Link Speed (mph)	25	
Link Distance (ft)	398	
Travel Time (s)	10.9	
Peak Hour Factor	0.92	0.92
Shared Lane Traffic (%)		
Lane Group Flow (vph)	156	0
Turn Type	NA	
Protected Phases	6	
Permitted Phases		
Total Split (s)	15.0	
Total Lost Time (s)	4.5	
Act Effct Green (s)	9.9	
Actuated g/C Ratio	0.20	
v/c Ratio	0.37	
Control Delay	10.2	
Queue Delay	0.0	
Total Delay	10.2	
LOS	B	
Approach Delay	25.2	
Approach LOS	C	
Queue Length 50th (ft)	10	
Queue Length 95th (ft)	52	
Internal Link Dist (ft)	318	
Turn Bay Length (ft)		
Base Capacity (vph)	447	
Starvation Cap Reductn	0	
Spillback Cap Reductn	0	
Storage Cap Reductn	0	
Reduced v/c Ratio	0.35	
Intersection Summary		

Lanes, Volumes, Timings  
2: Pomona Avenue & Orangethorpe Avenue

05/28/2021

Intersection Capacity Utilization 67.8% ICU Level of Service C

Analysis Period (min) 15

# 95th percentile volume exceeds capacity, queue may be longer.

Queue shown is maximum after two cycles.

Splits and Phases: 2: Pomona Avenue & Orangethorpe Avenue





Lanes, Volumes, Timings  
3: Lemon Street & Orangethorpe Avenue

05/28/2021



Lane Group	EBU	EBL	EBT	EBR	WBU	WBL	WBT	WBR	NBL	NBT	NBR	SBL
Lane Configurations		3	↑↑↑			3	↑↑		↑	↑↑	↑	↑
Traffic Volume (vph)	2	192	865	218	4	266	887	189	327	963	110	186
Future Volume (vph)	2	192	865	218	4	266	887	189	327	963	110	186
Ideal Flow (vphpl)	1800	1800	1900	1900	1750	1750	1900	1900	1800	1900	1900	1800
Storage Length (ft)		140		0		170		0	200		130	145
Storage Lanes		1		0		2		0	1		1	1
Taper Length (ft)		115				120			90			105
Satd. Flow (prot)	0	1676	4933	0	0	3162	3447	0	1676	3539	1583	1676
Flt Permitted		0.950				0.950			0.129			0.151
Satd. Flow (perm)	0	1676	4933	0	0	3162	3447	0	228	3539	1583	266
Right Turn on Red				Yes				Yes			Yes	
Satd. Flow (RTOR)			56				24				104	
Link Speed (mph)			40				40			40		
Link Distance (ft)			647				859			670		
Travel Time (s)			11.0				14.6			11.4		
Peak Hour Factor	0.92	0.92	0.92	0.92	0.92	0.92	0.92	0.92	0.92	0.92	0.92	0.92
Shared Lane Traffic (%)												
Lane Group Flow (vph)	0	211	1177	0	0	293	1169	0	355	1047	120	202
Turn Type	Prot	Prot	NA		Prot	Prot	NA		pm+pt	NA	Perm	pm+pt
Protected Phases	7	7	4		3	3	8		5	2		1
Permitted Phases									2		2	6
Total Split (s)	17.0	17.0	36.0		21.0	21.0	40.0		22.0	39.0	39.0	14.0
Total Lost Time (s)		4.5	4.5			4.5	4.5		4.5	4.5	4.5	4.5
Act Effct Green (s)		12.5	33.4			14.6	35.5		48.5	34.5	34.5	36.0
Actuated g/C Ratio		0.11	0.30			0.13	0.32		0.44	0.31	0.31	0.33
v/c Ratio		1.11	0.77			0.70	1.04		1.08	0.94	0.21	0.97
Control Delay		143.6	37.4			54.6	73.0		101.4	53.9	8.2	84.1
Queue Delay		0.0	0.0			0.0	0.0		0.0	0.0	0.0	0.0
Total Delay		143.6	37.4			54.6	73.0		101.4	53.9	8.2	84.1
LOS		F	D			D	E		F	D	A	F
Approach Delay			53.5				69.3			61.4		
Approach LOS			D				E			E		
Queue Length 50th (ft)		~171	266			102	~462		~231	377	8	94
Queue Length 95th (ft)		#321	327			146	#599		#417	#513	50	#245
Internal Link Dist (ft)			567				779			590		
Turn Bay Length (ft)		140				170			200		130	145
Base Capacity (vph)		190	1535			474	1128		330	1109	567	208
Starvation Cap Reductn		0	0			0	0		0	0	0	0
Spillback Cap Reductn		0	0			0	0		0	0	0	0
Storage Cap Reductn		0	0			0	0		0	0	0	0
Reduced v/c Ratio		1.11	0.77			0.62	1.04		1.08	0.94	0.21	0.97

Intersection Summary

Area Type:	Other
Cycle Length:	110
Actuated Cycle Length:	110
Control Type:	Actuated-Uncoordinated
Maximum v/c Ratio:	1.11
Intersection Signal Delay:	63.3
Intersection LOS:	E

Lanes, Volumes, Timings  
 3: Lemon Street & Orangethorpe Avenue

05/28/2021



Lane Group	SBT	SBR
Lane Configurations	↑↑	↑
Traffic Volume (vph)	797	142
Future Volume (vph)	797	142
Ideal Flow (vphpl)	1900	1900
Storage Length (ft)		175
Storage Lanes		1
Taper Length (ft)		
Satd. Flow (prot)	3539	1583
Flt Permitted		
Satd. Flow (perm)	3539	1583
Right Turn on Red		Yes
Satd. Flow (RTOR)		149
Link Speed (mph)	40	
Link Distance (ft)	291	
Travel Time (s)	5.0	
Peak Hour Factor	0.92	0.92
Shared Lane Traffic (%)		
Lane Group Flow (vph)	866	154
Turn Type	NA	Perm
Protected Phases	6	
Permitted Phases		6
Total Split (s)	31.0	31.0
Total Lost Time (s)	4.5	4.5
Act Effct Green (s)	26.5	26.5
Actuated g/C Ratio	0.24	0.24
v/c Ratio	1.02	0.31
Control Delay	76.9	7.9
Queue Delay	0.0	0.0
Total Delay	76.9	7.9
LOS	E	A
Approach Delay	69.4	
Approach LOS	E	
Queue Length 50th (ft)	~331	3
Queue Length 95th (ft)	#467	54
Internal Link Dist (ft)	211	
Turn Bay Length (ft)		175
Base Capacity (vph)	852	494
Starvation Cap Reductn	0	0
Spillback Cap Reductn	0	0
Storage Cap Reductn	0	0
Reduced v/c Ratio	1.02	0.31
<b>Intersection Summary</b>		

Intersection Capacity Utilization 98.0%

ICU Level of Service F

Analysis Period (min) 15

~ Volume exceeds capacity, queue is theoretically infinite.

Queue shown is maximum after two cycles.

# 95th percentile volume exceeds capacity, queue may be longer.

Queue shown is maximum after two cycles.

Splits and Phases: 3: Lemon Street & Orangethorpe Avenue

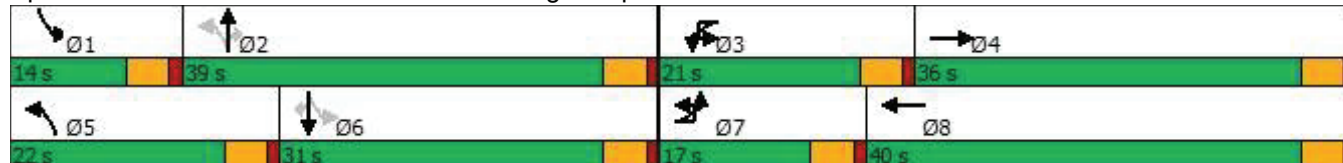

Lanes, Volumes, Timings  
 4: Lemon Street & South Project Access

05/28/2021



Lane Group	EBL	EBT	EBR	WBL	WBT	WBR	NBL	NBT	NBR	SBL	SBT	SBR
Lane Configurations			↗			↗		↕↔			↕↕	↗
Traffic Volume (vph)	0	0	74	0	0	52	0	1332	41	0	1022	23
Future Volume (vph)	0	0	74	0	0	52	0	1332	41	0	1022	23
Ideal Flow (vphpl)	1900	1900	1900	1900	1900	1900	1800	1900	1900	1800	1900	1900
Storage Length (ft)	0		0	0		0	20		0	50		0
Storage Lanes	0		1	0		1	0		0	0		1
Taper Length (ft)	25			25			25			25		
Satd. Flow (prot)	0	0	1611	0	0	1611	0	3522	0	0	3539	1583
Flt Permitted												
Satd. Flow (perm)	0	0	1611	0	0	1611	0	3522	0	0	3539	1583
Link Speed (mph)		25			30			40			40	
Link Distance (ft)		267			71			291			254	
Travel Time (s)		7.3			1.6			5.0			4.3	
Peak Hour Factor	0.92	0.92	0.92	0.92	0.92	0.92	0.92	0.92	0.92	0.92	0.92	0.92
Shared Lane Traffic (%)												
Lane Group Flow (vph)	0	0	80	0	0	57	0	1493	0	0	1111	25
Sign Control		Stop			Stop			Free			Free	

Intersection Summary

Area Type:	Other
Control Type:	Unsignalized
Intersection Capacity Utilization	48.1%
	ICU Level of Service A
Analysis Period (min)	15

HCM 6th TWSC  
4: Lemon Street & South Project Access

05/28/2021

**Intersection**

Int Delay, s/veh 0.8

Movement	EBL	EBT	EBR	WBL	WBT	WBR	NBL	NBT	NBR	SBL	SBT	SBR
Lane Configurations			↑			↑		↑↑			↑↑	↑
Traffic Vol, veh/h	0	0	74	0	0	52	0	1332	41	0	1022	23
Future Vol, veh/h	0	0	74	0	0	52	0	1332	41	0	1022	23
Conflicting Peds, #/hr	0	0	0	0	0	0	0	0	0	0	0	0
Sign Control	Stop	Stop	Stop	Stop	Stop	Stop	Free	Free	Free	Free	Free	Free
RT Channelized	-	-	None	-	-	None	-	-	None	-	-	None
Storage Length	-	-	0	-	-	0	-	-	-	-	-	0
Veh in Median Storage,-#	0	-	-	0	-	-	0	-	-	0	-	-
Grade, %	-	0	-	-	0	-	-	0	-	-	0	-
Peak Hour Factor	92	92	92	92	92	92	92	92	92	92	92	92
Heavy Vehicles, %	2	2	2	2	2	2	2	2	2	2	2	2
Mvmt Flow	0	0	80	0	0	57	0	1448	45	0	1111	25

Major/Minor	Minor2	Minor1	Major1	Major2								
Conflicting Flow All	-	-	556	-	-	747	-	0	0	-	-	0
Stage 1	-	-	-	-	-	-	-	-	-	-	-	-
Stage 2	-	-	-	-	-	-	-	-	-	-	-	-
Critical Hdwy	-	-	6.94	-	-	6.94	-	-	-	-	-	-
Critical Hdwy Stg 1	-	-	-	-	-	-	-	-	-	-	-	-
Critical Hdwy Stg 2	-	-	-	-	-	-	-	-	-	-	-	-
Follow-up Hdwy	-	-	3.32	-	-	3.32	-	-	-	-	-	-
Pot Cap-1 Maneuver	0	0	475	0	0	355	0	-	-	0	-	-
Stage 1	0	0	-	0	0	-	0	-	-	0	-	-
Stage 2	0	0	-	0	0	-	0	-	-	0	-	-
Platoon blocked, %								-	-	-	-	-
Mov Cap-1 Maneuver	-	-	475	-	-	355	-	-	-	-	-	-
Mov Cap-2 Maneuver	-	-	-	-	-	-	-	-	-	-	-	-
Stage 1	-	-	-	-	-	-	-	-	-	-	-	-
Stage 2	-	-	-	-	-	-	-	-	-	-	-	-

Approach	EB	WB	NB	SB
HCM Control Delay, s	14.1	17.1	0	0
HCM LOS	B	C		

Minor Lane/Major Mvmt	NBT	NBR	EBLn	WBLn1	SBT	SBR
Capacity (veh/h)	-	-	475	355	-	-
HCM Lane V/C Ratio	-	-	0.169	0.159	-	-
HCM Control Delay (s)	-	-	14.1	17.1	-	-
HCM Lane LOS	-	-	B	C	-	-
HCM 95th %tile Q(veh)	-	-	0.6	0.6	-	-

Lanes, Volumes, Timings  
5: Lemon Street & North Project Access/Liberty Avenue

08/17/2021



Lane Group	EBL	EBT	EBR	WBL	WBT	WBR	NBL	NBT	NBR	SBL	SBT	SBR
Lane Configurations		↕	↗		↔		↖	↕↔		↖	↕↕	↗
Traffic Volume (vph)	73	0	93	35	1	22	173	1170	11	1	902	74
Future Volume (vph)	73	0	93	35	1	22	173	1170	11	1	902	74
Ideal Flow (vphpl)	1900	1900	1900	1900	1900	1900	1800	1900	1900	1800	1900	1900
Storage Length (ft)	0		0	0		0	50		0	50		75
Storage Lanes	0		1	0		0	1		0	1		1
Taper Length (ft)	25			25			25			25		
Satd. Flow (prot)	0	1770	1583	0	1716	0	1676	3536	0	1676	3539	1583
Flt Permitted		0.950			0.971		0.183			0.161		
Satd. Flow (perm)	0	1770	1583	0	1716	0	323	3536	0	284	3539	1583
Right Turn on Red			Yes			Yes			Yes			Yes
Satd. Flow (RTOR)			127		24			1				127
Link Speed (mph)		30			25			40			40	
Link Distance (ft)		333			454			254			394	
Travel Time (s)		7.6			12.4			4.3			6.7	
Peak Hour Factor	0.92	0.92	0.92	0.92	0.92	0.92	0.92	0.92	0.92	0.92	0.92	0.92
Shared Lane Traffic (%)												
Lane Group Flow (vph)	0	79	101	0	63	0	188	1284	0	1	980	80
Turn Type	Split	NA	Perm	Split	NA		pm+pt	NA		pm+pt	NA	Perm
Protected Phases	4	4		8	8		5	2		1	6	
Permitted Phases			4				2			6		6
Total Split (s)	20.0	20.0	20.0	16.0	16.0		10.0	44.0		10.0	44.0	44.0
Total Lost Time (s)		4.5	4.5		4.5		4.5	4.5		4.5	4.5	4.5
Act Effct Green (s)		8.8	8.8		7.6		39.3	40.0		35.1	29.1	29.1
Actuated g/C Ratio		0.14	0.14		0.12		0.64	0.65		0.57	0.47	0.47
v/c Ratio		0.31	0.30		0.27		0.56	0.56		0.00	0.59	0.10
Control Delay		32.4	6.8		24.8		17.5	12.2		8.0	16.0	1.1
Queue Delay		0.0	0.0		0.0		0.0	0.0		0.0	0.0	0.0
Total Delay		32.4	6.8		24.8		17.5	12.2		8.0	16.0	1.1
LOS		C	A		C		B	B		A	B	A
Approach Delay		18.1			24.8			12.9			14.9	
Approach LOS		B			C			B			B	
Queue Length 50th (ft)		29	0		14		34	168		0	163	0
Queue Length 95th (ft)		81	29		56		#106	385		2	263	9
Internal Link Dist (ft)		253			374			174			314	
Turn Bay Length (ft)							50			50		75
Base Capacity (vph)		481	523		365		336	2447		295	2439	1130
Starvation Cap Reductn		0	0		0		0	21		0	0	0
Spillback Cap Reductn		0	0		0		0	0		0	0	0
Storage Cap Reductn		0	0		0		0	0		0	0	0
Reduced v/c Ratio		0.16	0.19		0.17		0.56	0.53		0.00	0.40	0.07

Intersection Summary

Area Type:	Other
Cycle Length:	90
Actuated Cycle Length:	61.8
Control Type:	Actuated-Uncoordinated
Maximum v/c Ratio:	0.59
Intersection Signal Delay:	14.3
Intersection LOS:	B



Lanes, Volumes, Timings

5: Lemon Street & North Project Access/Liberty Avenue

08/17/2021

Intersection Capacity Utilization 58.1%

ICU Level of Service B

Analysis Period (min) 15

# 95th percentile volume exceeds capacity, queue may be longer.

Queue shown is maximum after two cycles.

Splits and Phases: 5: Lemon Street & North Project Access/Liberty Avenue

 Ø1	 Ø2	 Ø4	 Ø8
10 s	44 s	20 s	16 s
 Ø5	 Ø6		
10 s	44 s		

## Appendix E – HCM/Synchro Reports – General Plan Year Conditions

Lanes, Volumes, Timings  
1: Harbor Boulevard & Orangethorpe Avenue

05/27/2021



Lane Group	EBL	EBT	EBR	WBU	WBL	WBT	WBR	NBL	NBT	NBR	SBU	SBL
Lane Configurations	↔	↑↑↑	↗		↔	↑↑↑	↗	↔↗	↑↑	↗		↔↗
Traffic Volume (vph)	195	859	211	3	155	499	171	116	1252	196	5	199
Future Volume (vph)	195	859	211	3	155	499	171	116	1252	196	5	199
Ideal Flow (vphpl)	1800	1900	1900	1800	1800	1900	1900	1750	1900	1900	1750	1750
Storage Length (ft)	200		130		240		140	120		250		270
Storage Lanes	1		1		1		1	2		0		2
Taper Length (ft)	90				60			90				100
Satd. Flow (prot)	1676	5085	1583	0	1676	5085	1583	3162	3539	1583	0	3162
Flt Permitted	0.950				0.950			0.950				0.950
Satd. Flow (perm)	1676	5085	1583	0	1676	5085	1583	3162	3539	1583	0	3162
Right Turn on Red			Yes				Yes			Yes		
Satd. Flow (RTOR)			209				186			212		
Link Speed (mph)		40				40			40			
Link Distance (ft)		787				701			655			
Travel Time (s)		13.4				11.9			11.2			
Peak Hour Factor	0.92	0.92	0.92	0.92	0.92	0.92	0.92	0.92	0.92	0.92	0.92	0.92
Shared Lane Traffic (%)												
Lane Group Flow (vph)	212	934	229	0	171	542	186	126	1361	213	0	221
Turn Type	Prot	NA	Perm	Prot	Prot	NA	Perm	Prot	NA	Perm	Prot	Prot
Protected Phases	7	4		3	3	8		5	2		1	1
Permitted Phases			4				8			2		
Total Split (s)	18.0	23.0	23.0	16.0	16.0	21.0	21.0	16.0	39.0	39.0	12.0	12.0
Total Lost Time (s)	4.5	4.5	4.5		4.5	4.5	4.5	4.5	4.5	4.5		4.5
Act Effct Green (s)	13.2	18.5	18.5		11.2	16.5	16.5	8.9	34.5	34.5		7.5
Actuated g/C Ratio	0.15	0.21	0.21		0.12	0.18	0.18	0.10	0.38	0.38		0.08
v/c Ratio	0.87	0.89	0.47		0.82	0.58	0.42	0.40	1.00	0.29		0.84
Control Delay	70.1	46.7	9.4		68.9	36.3	8.3	41.4	53.3	3.9		68.0
Queue Delay	0.0	0.0	0.0		0.0	0.0	0.0	0.0	0.0	0.0		0.0
Total Delay	70.1	46.7	9.4		68.9	36.3	8.3	41.4	53.3	3.9		68.0
LOS	E	D	A		E	D	A	D	D	A		E
Approach Delay		44.1				36.7			46.2			
Approach LOS		D				D			D			
Queue Length 50th (ft)	119	190	9		96	104	0	35	~402	0		64
Queue Length 95th (ft)	#241	#264	69		#202	140	55	61	#561	43		#127
Internal Link Dist (ft)		707				621			575			
Turn Bay Length (ft)	200		130		240		140	120		250		270
Base Capacity (vph)	252	1049	492		215	936	443	405	1361	739		264
Starvation Cap Reductn	0	0	0		0	0	0	0	0	0		0
Spillback Cap Reductn	0	0	0		0	0	0	0	0	0		0
Storage Cap Reductn	0	0	0		0	0	0	0	0	0		0
Reduced v/c Ratio	0.84	0.89	0.47		0.80	0.58	0.42	0.31	1.00	0.29		0.84

Intersection Summary

Area Type: Other  
 Cycle Length: 90  
 Actuated Cycle Length: 89.7  
 Control Type: Actuated-Uncoordinated  
 Maximum v/c Ratio: 1.00  
 Intersection Signal Delay: 45.9                      Intersection LOS: D

Lanes, Volumes, Timings  
 1: Harbor Boulevard & Orangethorpe Avenue

05/27/2021



Lane Group	SBT	SBR
Lane Configurations	↑↑↑	
Traffic Volume (vph)	1571	133
Future Volume (vph)	1571	133
Ideal Flow (vphpl)	1900	1900
Storage Length (ft)		160
Storage Lanes		0
Taper Length (ft)		
Satd. Flow (prot)	5024	0
Flt Permitted		
Satd. Flow (perm)	5024	0
Right Turn on Red		Yes
Satd. Flow (RTOR)	16	
Link Speed (mph)	40	
Link Distance (ft)	935	
Travel Time (s)	15.9	
Peak Hour Factor	0.92	0.92
Shared Lane Traffic (%)		
Lane Group Flow (vph)	1853	0
Turn Type	NA	
Protected Phases	6	
Permitted Phases		
Total Split (s)	35.0	
Total Lost Time (s)	4.5	
Act Effct Green (s)	33.1	
Actuated g/C Ratio	0.37	
v/c Ratio	0.99	
Control Delay	48.9	
Queue Delay	0.0	
Total Delay	48.9	
LOS	D	
Approach Delay	50.9	
Approach LOS	D	
Queue Length 50th (ft)	376	
Queue Length 95th (ft)	#531	
Internal Link Dist (ft)	855	
Turn Bay Length (ft)		
Base Capacity (vph)	1864	
Starvation Cap Reductn	0	
Spillback Cap Reductn	0	
Storage Cap Reductn	0	
Reduced v/c Ratio	0.99	
Intersection Summary		

# Lanes, Volumes, Timings

## 1: Harbor Boulevard & Orangethorpe Avenue

05/27/2021

Intersection Capacity Utilization 81.8%      ICU Level of Service D

Analysis Period (min) 15

~ Volume exceeds capacity, queue is theoretically infinite.

Queue shown is maximum after two cycles.

# 95th percentile volume exceeds capacity, queue may be longer.

Queue shown is maximum after two cycles.

Splits and Phases: 1: Harbor Boulevard & Orangethorpe Avenue

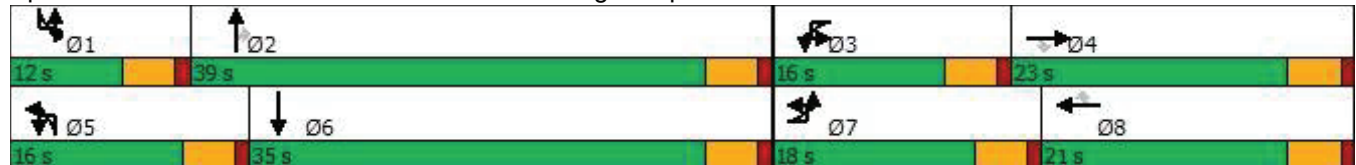

Lanes, Volumes, Timings  
2: Pomona Avenue & Orangethorpe Avenue

05/27/2021



Lane Group	EBU	EBL	EBT	EBR	WBU	WBL	WBT	WBR	NBL	NBT	NBR	SBL
Lane Configurations		↔	↑↑↑				↔	↑↑	↔	↔		↔
Traffic Volume (vph)	2	101	1231	53	21	24	729	91	58	19	29	77
Future Volume (vph)	2	101	1231	53	21	24	729	91	58	19	29	77
Ideal Flow (vphpl)	1800	1800	1900	1900	1800	1800	1900	1900	1800	1900	1900	1800
Storage Length (ft)		140		0		150		70	95		0	70
Storage Lanes		1		0		1		1	1		0	1
Taper Length (ft)		60				70			30			60
Satd. Flow (prot)	0	1676	5055	0	0	1676	3539	1583	1676	1693	0	1676
Flt Permitted		0.352				0.172			0.727			0.727
Satd. Flow (perm)	0	621	5055	0	0	304	3539	1583	1283	1693	0	1283
Right Turn on Red				Yes				Yes			Yes	
Satd. Flow (RTOR)			28					99		32		
Link Speed (mph)			40				40			25		
Link Distance (ft)			701				647			214		
Travel Time (s)			11.9				11.0			5.8		
Peak Hour Factor	0.92	0.92	0.92	0.92	0.92	0.92	0.92	0.92	0.92	0.92	0.92	0.92
Shared Lane Traffic (%)												
Lane Group Flow (vph)	0	112	1396	0	0	49	792	99	63	53	0	84
Turn Type	Perm	Perm	NA		Perm	Perm	NA	Perm	Perm	NA		Perm
Protected Phases			4				8			2		
Permitted Phases	4	4			8	8		8	2			6
Total Split (s)	33.0	33.0	33.0		33.0	33.0	33.0	33.0	12.0	12.0		12.0
Total Lost Time (s)		4.5	4.5				4.5	4.5	4.5	4.5		4.5
Act Effct Green (s)		27.3	27.3				27.3	27.3	27.3	7.0	7.0	7.0
Actuated g/C Ratio		0.69	0.69				0.69	0.69	0.69	0.18	0.18	0.18
v/c Ratio		0.26	0.40				0.23	0.33	0.09	0.28	0.16	0.37
Control Delay		5.9	4.2				7.3	4.1	1.2	19.2	10.8	21.1
Queue Delay		0.0	0.0				0.0	0.0	0.0	0.0	0.0	0.0
Total Delay		5.9	4.2				7.3	4.1	1.2	19.2	10.8	21.1
LOS		A	A				A	A	A	B	B	C
Approach Delay			4.3				4.0			15.4		
Approach LOS			A				A			B		
Queue Length 50th (ft)		10	50				4	39	0	11	4	15
Queue Length 95th (ft)		29	69				18	60	10	41	26	51
Internal Link Dist (ft)			621					567		134		
Turn Bay Length (ft)		140					150		70	95		70
Base Capacity (vph)		456	3727				223	2604	1191	248	353	248
Starvation Cap Reductn		0	0				0	0	0	0	0	0
Spillback Cap Reductn		0	0				0	0	0	0	0	0
Storage Cap Reductn		0	0				0	0	0	0	0	0
Reduced v/c Ratio		0.25	0.37				0.22	0.30	0.08	0.25	0.15	0.34

Intersection Summary

Area Type: Other  
 Cycle Length: 45  
 Actuated Cycle Length: 39.6  
 Control Type: Actuated-Uncoordinated  
 Maximum v/c Ratio: 0.40  
 Intersection Signal Delay: 5.3                      Intersection LOS: A



Lanes, Volumes, Timings  
 2: Pomona Avenue & Orangethorpe Avenue

05/27/2021



Lane Group	SBT	SBR
Lane Configurations	7	68
Traffic Volume (vph)	7	68
Future Volume (vph)	7	68
Ideal Flow (vphpl)	1900	1900
Storage Length (ft)		0
Storage Lanes		0
Taper Length (ft)		
Satd. Flow (prot)	1611	0
Flt Permitted		
Satd. Flow (perm)	1611	0
Right Turn on Red		Yes
Satd. Flow (RTOR)	74	
Link Speed (mph)	25	
Link Distance (ft)	398	
Travel Time (s)	10.9	
Peak Hour Factor	0.92	0.92
Shared Lane Traffic (%)		
Lane Group Flow (vph)	82	0
Turn Type	NA	
Protected Phases	6	
Permitted Phases		
Total Split (s)	12.0	
Total Lost Time (s)	4.5	
Act Effct Green (s)	7.0	
Actuated g/C Ratio	0.18	
v/c Ratio	0.24	
Control Delay	8.0	
Queue Delay	0.0	
Total Delay	8.0	
LOS	A	
Approach Delay	14.7	
Approach LOS	B	
Queue Length 50th (ft)	1	
Queue Length 95th (ft)	28	
Internal Link Dist (ft)	318	
Turn Bay Length (ft)		
Base Capacity (vph)	371	
Starvation Cap Reductn	0	
Spillback Cap Reductn	0	
Storage Cap Reductn	0	
Reduced v/c Ratio	0.22	
Intersection Summary		

Lanes, Volumes, Timings  
2: Pomona Avenue & Orangethorpe Avenue

05/27/2021

Intersection Capacity Utilization 51.5%      ICU Level of Service A  
Analysis Period (min) 15

Splits and Phases: 2: Pomona Avenue & Orangethorpe Avenue





Lanes, Volumes, Timings  
 3: Lemon Street & Orangethorpe Avenue

05/27/2021

Lane Group	SBR
Lane Configurations	
Traffic Volume (vph)	84
Future Volume (vph)	84
Ideal Flow (vphpl)	1900
Storage Length (ft)	175
Storage Lanes	1
Taper Length (ft)	
Satd. Flow (prot)	1583
Flt Permitted	
Satd. Flow (perm)	1583
Right Turn on Red	Yes
Satd. Flow (RTOR)	127
Link Speed (mph)	
Link Distance (ft)	
Travel Time (s)	
Peak Hour Factor	0.92
Shared Lane Traffic (%)	
Lane Group Flow (vph)	91
Turn Type	Perm
Protected Phases	
Permitted Phases	6
Total Split (s)	29.0
Total Lost Time (s)	4.5
Act Effct Green (s)	24.5
Actuated g/C Ratio	0.27
v/c Ratio	0.17
Control Delay	2.9
Queue Delay	0.0
Total Delay	2.9
LOS	A
Approach Delay	
Approach LOS	
Queue Length 50th (ft)	0
Queue Length 95th (ft)	19
Internal Link Dist (ft)	
Turn Bay Length (ft)	175
Base Capacity (vph)	523
Starvation Cap Reductn	0
Spillback Cap Reductn	0
Storage Cap Reductn	0
Reduced v/c Ratio	0.17
Intersection Summary	

Lanes, Volumes, Timings  
 3: Lemon Street & Orangethorpe Avenue

05/27/2021

Intersection Capacity Utilization 84.0% ICU Level of Service E

Analysis Period (min) 15

# 95th percentile volume exceeds capacity, queue may be longer.





















Queue shown is maximum after two cycles.

Splits and Phases: 3: Lemon Street & Orangethorpe Avenue



Lanes, Volumes, Timings  
 4: Lemon Street & South Project Access

05/27/2021

												
Lane Group	EBL	EBT	EBR	WBL	WBT	WBR	NBL	NBT	NBR	SBL	SBT	SBR
Lane Configurations												
Traffic Volume (vph)	2	0	47	0	0	4	4	977	4	0	1134	28
Future Volume (vph)	2	0	47	0	0	4	4	977	4	0	1134	28
Ideal Flow (vphpl)	1900	1900	1900	1900	1900	1900	1800	1900	1900	1800	1900	1900
Storage Length (ft)	0		0	0		0	20		0	50		0
Storage Lanes	0		0	0		1	1		0	1		0
Taper Length (ft)	25			25			25			25		
Satd. Flow (prot)	0	1617	0	0	1863	1583	1676	3536	0	1765	3525	0
Flt Permitted		0.998					0.950					
Satd. Flow (perm)	0	1617	0	0	1863	1583	1676	3536	0	1765	3525	0
Link Speed (mph)		25			30			40			40	
Link Distance (ft)		267			71			291			254	
Travel Time (s)		7.3			1.6			5.0			4.3	
Peak Hour Factor	0.92	0.92	0.92	0.92	0.92	0.92	0.92	0.92	0.92	0.92	0.92	0.92
Shared Lane Traffic (%)												
Lane Group Flow (vph)	0	53	0	0	0	4	4	1066	0	0	1263	0
Sign Control		Stop			Stop			Free			Free	
<b>Intersection Summary</b>												
Area Type:	Other											
Control Type:	Unsignalized											
Intersection Capacity Utilization	43.8%					ICU Level of Service A						
Analysis Period (min)	15											



HCM 6th TWSC  
4: Lemon Street & South Project Access

05/27/2021

Intersection												
Int Delay, s/veh	0.4											
Movement	EBL	EBT	EBR	WBL	WBT	WBR	NBL	NBT	NBR	SBL	SBT	SBR
Lane Configurations		↕			↕	↕	↕	↕		↕	↕	
Traffic Vol, veh/h	2	0	47	0	0	4	4	977	4	0	1134	28
Future Vol, veh/h	2	0	47	0	0	4	4	977	4	0	1134	28
Conflicting Peds, #/hr	0	0	0	0	0	0	0	0	0	0	0	0
Sign Control	Stop	Stop	Stop	Stop	Stop	Stop	Free	Free	Free	Free	Free	Free
RT Channelized	-	-	None	-	-	None	-	-	None	-	-	None
Storage Length	-	-	-	-	-	0	20	-	-	50	-	-
Veh in Median Storage, #	0	-	-	0	-	-	0	-	-	0	-	-
Grade, %	-	0	-	-	0	-	-	0	-	-	0	-
Peak Hour Factor	92	92	92	92	92	92	92	92	92	92	92	92
Heavy Vehicles, %	2	2	2	2	2	2	2	2	2	2	2	2
Mvmt Flow	2	0	51	0	0	4	4	1062	4	0	1233	30

Major/Minor	Minor2	Minor1		Major1		Major2						
Conflicting Flow All	1787	2322	632	1689	2335	533	1263	0	0	1066	0	0
Stage 1	1248	1248	-	1072	1072	-	-	-	-	-	-	-
Stage 2	539	1074	-	617	1263	-	-	-	-	-	-	-
Critical Hdwy	7.54	6.54	6.94	7.54	6.54	6.94	4.14	-	-	4.14	-	-
Critical Hdwy Stg 1	6.54	5.54	-	6.54	5.54	-	-	-	-	-	-	-
Critical Hdwy Stg 2	6.54	5.54	-	6.54	5.54	-	-	-	-	-	-	-
Follow-up Hdwy	3.52	4.02	3.32	3.52	4.02	3.32	2.22	-	-	2.22	-	-
Pot Cap-1 Maneuver	51	37	423	61	36	491	546	-	-	649	-	-
Stage 1	183	243	-	235	295	-	-	-	-	-	-	-
Stage 2	494	294	-	444	239	-	-	-	-	-	-	-
Platoon blocked, %								-	-	-	-	-
Mov Cap-1 Maneuver	50	37	423	53	36	491	546	-	-	649	-	-
Mov Cap-2 Maneuver	50	37	-	53	36	-	-	-	-	-	-	-
Stage 1	182	243	-	233	293	-	-	-	-	-	-	-
Stage 2	486	292	-	390	239	-	-	-	-	-	-	-

Approach	EB	WB	NB	SB
HCM Control Delay, s	18.3	12.4	0	0
HCM LOS	C	B		

Minor Lane/Major Mvmt	NBL	NBT	NBR	EBLn	WBLn	WBLn2	SBL	SBT	SBR
Capacity (veh/h)	546	-	-	324	-	491	649	-	-
HCM Lane V/C Ratio	0.008	-	-	0.164	-	0.009	-	-	-
HCM Control Delay (s)	11.6	-	-	18.3	0	12.4	0	-	-
HCM Lane LOS	B	-	-	C	A	B	A	-	-
HCM 95th %tile Q(veh)	0	-	-	0.6	-	0	0	-	-

Lanes, Volumes, Timings

5: Lemon Street & North Project Access/Liberty Avenue

05/27/2021



Lane Group	EBL	EBT	EBR	WBL	WBT	WBR	NBL	NBT	NBR	SBL	SBT	SBR
Lane Configurations		↔	↔		↔		↔	↔		↔	↔	
Traffic Volume (vph)	19	0	61	54	2	12	24	829	98	30	1046	19
Future Volume (vph)	19	0	61	54	2	12	24	829	98	30	1046	19
Ideal Flow (vphpl)	1900	1900	1900	1900	1900	1900	1800	1900	1900	1800	1900	1900
Storage Length (ft)	0		0	0		0	50		0	50		0
Storage Lanes	0		1	0		0	1		0	1		0
Taper Length (ft)	25			25			25			25		
Satd. Flow (prot)	0	1770	1583	0	1749	0	1676	3483	0	1676	3529	0
Flt Permitted		0.950			0.962		0.950			0.950		
Satd. Flow (perm)	0	1770	1583	0	1749	0	1676	3483	0	1676	3529	0
Link Speed (mph)		30			25			40			40	
Link Distance (ft)		333			454			254			394	
Travel Time (s)		7.6			12.4			4.3			6.7	
Peak Hour Factor	0.92	0.92	0.92	0.92	0.92	0.92	0.92	0.92	0.92	0.92	0.92	0.92
Shared Lane Traffic (%)												
Lane Group Flow (vph)	0	21	66	0	74	0	26	1008	0	33	1158	0
Sign Control		Stop			Stop			Free			Free	

Intersection Summary

Area Type:	Other
Control Type:	Unsignalized
Intersection Capacity Utilization	47.1%
	ICU Level of Service A
Analysis Period (min)	15

HCM 6th TWSC  
5: Lemon Street & North Project Access/Liberty Avenue

05/27/2021

Intersection												
Int Delay, s/veh	10.6											
Movement	EBL	EBT	EBR	WBL	WBT	WBR	NBL	NBT	NBR	SBL	SBT	SBR
Lane Configurations		↕	↗		↕		↗	↕↗		↗	↕↗	
Traffic Vol, veh/h	19	0	61	54	2	12	24	829	98	30	1046	19
Future Vol, veh/h	19	0	61	54	2	12	24	829	98	30	1046	19
Conflicting Peds, #/hr	0	0	0	0	0	0	0	0	0	0	0	0
Sign Control	Stop	Stop	Stop	Stop	Stop	Stop	Free	Free	Free	Free	Free	Free
RT Channelized	-	-	None	-	-	None	-	-	None	-	-	None
Storage Length	-	-	0	-	-	-	50	-	-	50	-	-
Veh in Median Storage, #	0	-	-	0	-	-	0	-	-	0	-	-
Grade, %	-	0	-	-	0	-	-	0	-	-	0	-
Peak Hour Factor	92	92	92	92	92	92	92	92	92	92	92	92
Heavy Vehicles, %	2	2	2	2	2	2	2	2	2	2	2	2
Mvmt Flow	21	0	66	59	2	13	26	901	107	33	1137	21

Major/Minor	Minor2	Minor1		Major1		Major2						
Conflicting Flow All	1718	2274	579	1642	2231	504	1158	0	0	1008	0	0
Stage 1	1214	1214	-	1007	1007	-	-	-	-	-	-	-
Stage 2	504	1060	-	635	1224	-	-	-	-	-	-	-
Critical Hdwy	7.54	6.54	6.94	7.54	6.54	6.94	4.14	-	-	4.14	-	-
Critical Hdwy Stg 1	6.54	5.54	-	6.54	5.54	-	-	-	-	-	-	-
Critical Hdwy Stg 2	6.54	5.54	-	6.54	5.54	-	-	-	-	-	-	-
Follow-up Hdwy	3.52	4.02	3.32	3.52	4.02	3.32	2.22	-	-	2.22	-	-
Pot Cap-1 Maneuver	58	40	458	66	42	513	599	-	-	683	-	-
Stage 1	193	253	-	258	317	-	-	-	-	-	-	-
Stage 2	518	299	-	433	250	-	-	-	-	-	-	-
Platoon blocked, %								-	-	-	-	-
Mov Cap-1 Maneuver	50	36	458	~ 53	38	513	599	-	-	683	-	-
Mov Cap-2 Maneuver	50	36	-	~ 53	38	-	-	-	-	-	-	-
Stage 1	185	241	-	247	303	-	-	-	-	-	-	-
Stage 2	479	286	-	352	238	-	-	-	-	-	-	-

Approach	EB	WB	NB	SB
HCM Control Delay, s	39.4	288	0.3	0.3
HCM LOS	E	F		

Minor Lane/Major Mvmt	NBL	NBT	NBR	EBLn	EBLn1	WBLn	SBL	SBT	SBR
Capacity (veh/h)	599	-	-	50	458	62	683	-	-
HCM Lane V/C Ratio	0.044	-	-	0.413	0.145	1.192	0.048	-	-
HCM Control Delay (s)	11.3	-	-	120.5	14.2	288	10.5	-	-
HCM Lane LOS	B	-	-	F	B	F	B	-	-
HCM 95th %tile Q(veh)	0.1	-	-	1.5	0.5	6.1	0.1	-	-

Notes  
 ~: Volume exceeds capacity    \$: Delay exceeds 300s    +: Computation Not Defined    \*: All major volume in platoon

Lanes, Volumes, Timings  
1: Harbor Boulevard & Orangethorpe Avenue

05/27/2021



Lane Group	EBU	EBL	EBT	EBR	WBU	WBL	WBT	WBR	NBU	NBL	NBT	NBR
Lane Configurations		↔	↑↑↑	↗		↔	↑↑↑	↗		↔↗	↑↑	↗
Traffic Volume (vph)	2	249	828	190	16	243	995	205	1	245	1292	240
Future Volume (vph)	2	249	828	190	16	243	995	205	1	245	1292	240
Ideal Flow (vphpl)	1800	1800	1900	1900	1800	1800	1900	1900	1750	1750	1900	1900
Storage Length (ft)		200		130		240		140		120		250
Storage Lanes		1		1		1		1		2		0
Taper Length (ft)		90				60				90		
Satd. Flow (prot)	0	1676	5085	1583	0	1676	5085	1583	0	3162	3539	1583
Flt Permitted		0.950				0.950				0.950		
Satd. Flow (perm)	0	1676	5085	1583	0	1676	5085	1583	0	3162	3539	1583
Right Turn on Red				Yes				Yes				Yes
Satd. Flow (RTOR)				145				139				196
Link Speed (mph)			40				40				40	
Link Distance (ft)			787				701				655	
Travel Time (s)			13.4				11.9				11.2	
Peak Hour Factor	0.92	0.92	0.92	0.92	0.92	0.92	0.92	0.92	0.92	0.92	0.92	0.92
Shared Lane Traffic (%)												
Lane Group Flow (vph)	0	273	900	207	0	281	1082	223	0	267	1404	261
Turn Type	Prot	Prot	NA	Perm	Prot	Prot	NA	Perm	Prot	Prot	NA	Perm
Protected Phases	7	7	4		3	3	8		5	5	2	
Permitted Phases				4				8				2
Total Split (s)	21.0	21.0	28.0	28.0	25.0	25.0	32.0	32.0	16.8	16.8	53.0	53.0
Total Lost Time (s)		4.5	4.5	4.5			4.5	4.5		4.5	4.5	4.5
Act Effct Green (s)		16.5	23.5	23.5			20.5	27.5		12.2	48.5	48.5
Actuated g/C Ratio		0.14	0.20	0.20			0.17	0.23		0.10	0.40	0.40
v/c Ratio		1.19	0.90	0.49			0.98	0.93		0.83	0.98	0.35
Control Delay		164.0	60.5	18.2			99.0	59.5		74.9	55.5	8.0
Queue Delay		0.0	0.0	0.0			0.0	0.0		0.0	0.0	0.0
Total Delay		164.0	60.5	18.2			99.0	59.5		74.9	55.5	8.0
LOS		F	E	B			F	E		E	E	A
Approach Delay			74.6				60.8				51.8	
Approach LOS			E				E				D	
Queue Length 50th (ft)		~254	251	41			219	302		106	557	31
Queue Length 95th (ft)		#427	#327	116			#396	#388		#175	#723	90
Internal Link Dist (ft)			707				621				575	
Turn Bay Length (ft)		200		130			240			120		250
Base Capacity (vph)		230	995	426			286	1165		324	1430	756
Starvation Cap Reductn		0	0	0			0	0		0	0	0
Spillback Cap Reductn		0	0	0			0	0		0	0	0
Storage Cap Reductn		0	0	0			0	0		0	0	0
Reduced v/c Ratio		1.19	0.90	0.49			0.98	0.93		0.82	0.98	0.35

Intersection Summary

Area Type:	Other
Cycle Length:	120
Actuated Cycle Length:	120
Control Type:	Actuated-Uncoordinated
Maximum v/c Ratio:	1.19
Intersection Signal Delay:	57.0
Intersection LOS:	E

Lanes, Volumes, Timings  
 1: Harbor Boulevard & Orangethorpe Avenue

05/27/2021



Lane Group	SBU	SBL	SBT	SBR
Lane Configurations		57	↑↑↑	
Traffic Volume (vph)	13	208	1248	220
Future Volume (vph)	13	208	1248	220
Ideal Flow (vphpl)	1750	1750	1900	1900
Storage Length (ft)		270		160
Storage Lanes		2		0
Taper Length (ft)		100		
Satd. Flow (prot)	0	3162	4973	0
Flt Permitted		0.950		
Satd. Flow (perm)	0	3162	4973	0
Right Turn on Red				Yes
Satd. Flow (RTOR)			33	
Link Speed (mph)			40	
Link Distance (ft)			935	
Travel Time (s)			15.9	
Peak Hour Factor	0.92	0.92	0.92	0.92
Shared Lane Traffic (%)				
Lane Group Flow (vph)	0	240	1596	0
Turn Type	Prot	Prot	NA	
Protected Phases	1	1	6	
Permitted Phases				
Total Split (s)	14.0	14.0	50.2	
Total Lost Time (s)		4.5	4.5	
Act Effct Green (s)		9.5	45.8	
Actuated g/C Ratio		0.08	0.38	
v/c Ratio		0.96	0.83	
Control Delay		102.8	37.6	
Queue Delay		0.0	0.0	
Total Delay		102.8	37.6	
LOS		F	D	
Approach Delay			46.1	
Approach LOS			D	
Queue Length 50th (ft)		96	399	
Queue Length 95th (ft)		#180	463	
Internal Link Dist (ft)			855	
Turn Bay Length (ft)		270		
Base Capacity (vph)		250	1919	
Starvation Cap Reductn		0	0	
Spillback Cap Reductn		0	0	
Storage Cap Reductn		0	0	
Reduced v/c Ratio		0.96	0.83	
Intersection Summary				

# Lanes, Volumes, Timings

## 1: Harbor Boulevard & Orangethorpe Avenue

05/27/2021

Intersection Capacity Utilization 91.5%      ICU Level of Service F

Analysis Period (min) 15

~ Volume exceeds capacity, queue is theoretically infinite.

Queue shown is maximum after two cycles.

# 95th percentile volume exceeds capacity, queue may be longer.

Queue shown is maximum after two cycles.

Splits and Phases: 1: Harbor Boulevard & Orangethorpe Avenue

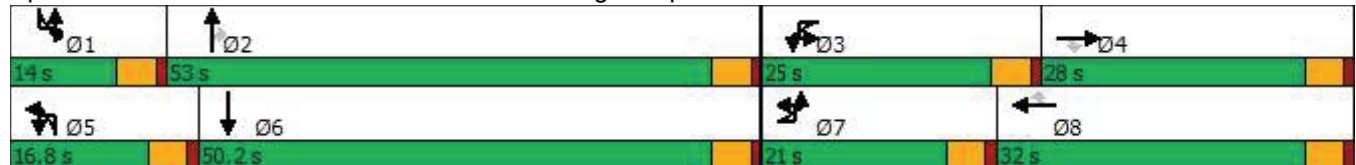



Lanes, Volumes, Timings  
2: Pomona Avenue & Orangethorpe Avenue

05/27/2021



Lane Group	EBU	EBL	EBT	EBR	WBU	WBL	WBT	WBR	NBL	NBT	NBR	SBL
Lane Configurations		↔	↑↑↑			↔	↑↑	↔	↔	↔		↔
Traffic Volume (vph)	5	175	858	85	11	53	986	167	93	40	80	155
Future Volume (vph)	5	175	858	85	11	53	986	167	93	40	80	155
Ideal Flow (vphpl)	1800	1800	1900	1900	1800	1800	1900	1900	1800	1900	1900	1800
Storage Length (ft)		140		0		150		70	95		0	70
Storage Lanes		1		0		1		1	1		0	1
Taper Length (ft)		60				70			30			60
Satd. Flow (prot)	0	1676	5019	0	0	1676	3539	1583	1676	1676	0	1676
Flt Permitted		0.231				0.262			0.657			0.674
Satd. Flow (perm)	0	408	5019	0	0	462	3539	1583	1159	1676	0	1189
Right Turn on Red				Yes				Yes			Yes	
Satd. Flow (RTOR)			57					182		87		
Link Speed (mph)			40				40			25		
Link Distance (ft)			701				647			214		
Travel Time (s)			11.9				11.0			5.8		
Peak Hour Factor	0.92	0.92	0.92	0.92	0.92	0.92	0.92	0.92	0.92	0.92	0.92	0.92
Shared Lane Traffic (%)												
Lane Group Flow (vph)	0	195	1025	0	0	70	1072	182	101	130	0	168
Turn Type	Perm	Perm	NA		Perm	Perm	NA	Perm	Perm	NA		Perm
Protected Phases			4				8			2		
Permitted Phases	4	4			8	8		8	2			6
Total Split (s)	44.0	44.0	44.0		44.0	44.0	44.0	44.0	16.0	16.0		16.0
Total Lost Time (s)		4.5	4.5			4.5	4.5	4.5	4.5	4.5		4.5
Act Effct Green (s)		33.2	33.2			33.2	33.2	33.2	10.6	10.6		10.6
Actuated g/C Ratio		0.63	0.63			0.63	0.63	0.63	0.20	0.20		0.20
v/c Ratio		0.76	0.32			0.24	0.48	0.17	0.44	0.32		0.71
Control Delay		31.4	4.6			6.8	6.1	1.2	27.1	11.7		41.1
Queue Delay		0.0	0.0			0.0	0.0	0.0	0.0	0.0		0.0
Total Delay		31.4	4.6			6.8	6.1	1.2	27.1	11.7		41.1
LOS		C	A			A	A	A	C	B		D
Approach Delay			8.9				5.5			18.4		
Approach LOS			A				A			B		
Queue Length 50th (ft)		38	44			8	81	0	29	12		52
Queue Length 95th (ft)		#157	60			25	114	15	74	53		#145
Internal Link Dist (ft)			621				567			134		
Turn Bay Length (ft)		140				150		70	95			70
Base Capacity (vph)		310	3826			351	2688	1246	256	438		262
Starvation Cap Reductn		0	0			0	0	0	0	0		0
Spillback Cap Reductn		0	0			0	0	0	0	0		0
Storage Cap Reductn		0	0			0	0	0	0	0		0
Reduced v/c Ratio		0.63	0.27			0.20	0.40	0.15	0.39	0.30		0.64

Intersection Summary

Area Type:	Other
Cycle Length:	60
Actuated Cycle Length:	53
Control Type:	Actuated-Uncoordinated
Maximum v/c Ratio:	0.76
Intersection Signal Delay:	10.0
Intersection LOS:	A

Lanes, Volumes, Timings  
 2: Pomona Avenue & Orangethorpe Avenue

05/27/2021



Lane Group	SBT	SBR
Lane Configurations		
Traffic Volume (vph)	37	108
Future Volume (vph)	37	108
Ideal Flow (vphpl)	1900	1900
Storage Length (ft)		0
Storage Lanes		0
Taper Length (ft)		
Satd. Flow (prot)	1654	0
Flt Permitted		
Satd. Flow (perm)	1654	0
Right Turn on Red		Yes
Satd. Flow (RTOR)	117	
Link Speed (mph)	25	
Link Distance (ft)	398	
Travel Time (s)	10.9	
Peak Hour Factor	0.92	0.92
Shared Lane Traffic (%)		
Lane Group Flow (vph)	157	0
Turn Type	NA	
Protected Phases	6	
Permitted Phases		
Total Split (s)	16.0	
Total Lost Time (s)	4.5	
Act Effct Green (s)	10.6	
Actuated g/C Ratio	0.20	
v/c Ratio	0.37	
Control Delay	10.7	
Queue Delay	0.0	
Total Delay	10.7	
LOS	B	
Approach Delay	26.4	
Approach LOS	C	
Queue Length 50th (ft)	11	
Queue Length 95th (ft)	55	
Internal Link Dist (ft)	318	
Turn Bay Length (ft)		
Base Capacity (vph)	456	
Starvation Cap Reductn	0	
Spillback Cap Reductn	0	
Storage Cap Reductn	0	
Reduced v/c Ratio	0.34	
Intersection Summary		

Lanes, Volumes, Timings  
2: Pomona Avenue & Orangethorpe Avenue

05/27/2021

Intersection Capacity Utilization 68.9% ICU Level of Service C

Analysis Period (min) 15

# 95th percentile volume exceeds capacity, queue may be longer.

Queue shown is maximum after two cycles.

Splits and Phases: 2: Pomona Avenue & Orangethorpe Avenue



Lanes, Volumes, Timings  
 3: Lemon Street & Orangethorpe Avenue

05/27/2021



Lane Group	EBU	EBL	EBT	EBR	WBU	WBL	WBT	WBR	NBL	NBT	NBR	SBL
Lane Configurations		↔	↑↑↑			↔	↑↑		↔	↑↑	↔	↔
Traffic Volume (vph)	2	199	895	224	4	275	916	194	333	988	114	192
Future Volume (vph)	2	199	895	224	4	275	916	194	333	988	114	192
Ideal Flow (vphpl)	1800	1800	1900	1900	1750	1750	1900	1900	1800	1900	1900	1800
Storage Length (ft)		140		0		170		0	200		130	145
Storage Lanes		1		0		2		0	1		1	1
Taper Length (ft)		115				120			90			105
Satd. Flow (prot)	0	1676	4933	0	0	3162	3447	0	1676	3539	1583	1676
Flt Permitted		0.950				0.950			0.114			0.131
Satd. Flow (perm)	0	1676	4933	0	0	3162	3447	0	201	3539	1583	231
Right Turn on Red				Yes				Yes			Yes	
Satd. Flow (RTOR)			55				23				95	
Link Speed (mph)			40				40			40		
Link Distance (ft)			647				859			670		
Travel Time (s)			11.0				14.6			11.4		
Peak Hour Factor	0.92	0.92	0.92	0.92	0.92	0.92	0.92	0.92	0.92	0.92	0.92	0.92
Shared Lane Traffic (%)												
Lane Group Flow (vph)	0	218	1216	0	0	303	1207	0	362	1074	124	209
Turn Type	Prot	Prot	NA		Prot	Prot	NA		pm+pt	NA	Perm	pm+pt
Protected Phases	7	7	4		3	3	8		5	2		1
Permitted Phases									2		2	6
Total Split (s)	17.0	17.0	46.0		18.0	18.0	47.0		21.0	41.0	41.0	15.0
Total Lost Time (s)		4.5	4.5			4.5	4.5		4.5	4.5	4.5	4.5
Act Effct Green (s)		12.5	41.6			13.4	42.5		51.5	36.5	36.5	41.0
Actuated g/C Ratio		0.10	0.35			0.11	0.35		0.43	0.30	0.30	0.34
v/c Ratio		1.25	0.70			0.86	0.98		1.25	1.00	0.23	1.02
Control Delay		196.1	34.7			75.7	58.6		169.4	68.9	10.7	99.5
Queue Delay		0.0	0.0			0.0	0.0		0.0	0.0	0.0	0.0
Total Delay		196.1	34.7			75.7	58.6		169.4	68.9	10.7	99.5
LOS		F	C			E	E		F	E	B	F
Approach Delay			59.2				62.0			87.6		
Approach LOS			E				E			F		
Queue Length 50th (ft)		~211	283			120	475		~304	436	16	~118
Queue Length 95th (ft)		#369	336			#196	#631		#497	#588	62	#280
Internal Link Dist (ft)			567				779			590		
Turn Bay Length (ft)		140				170			200		130	145
Base Capacity (vph)		174	1745			355	1235		289	1076	547	205
Starvation Cap Reductn		0	0			0	0		0	0	0	0
Spillback Cap Reductn		0	0			0	0		0	0	0	0
Storage Cap Reductn		0	0			0	0		0	0	0	0
Reduced v/c Ratio		1.25	0.70			0.85	0.98		1.25	1.00	0.23	1.02

Intersection Summary

Area Type:	Other
Cycle Length:	120
Actuated Cycle Length:	120
Control Type:	Actuated-Uncoordinated
Maximum v/c Ratio:	1.25
Intersection Signal Delay:	69.9
Intersection LOS:	E

Lanes, Volumes, Timings  
 3: Lemon Street & Orangethorpe Avenue

05/27/2021



Lane Group	SBT	SBR
Lane Configurations	↑↑	↑
Traffic Volume (vph)	822	147
Future Volume (vph)	822	147
Ideal Flow (vphpl)	1900	1900
Storage Length (ft)		175
Storage Lanes		1
Taper Length (ft)		
Satd. Flow (prot)	3539	1583
Flt Permitted		
Satd. Flow (perm)	3539	1583
Right Turn on Red		Yes
Satd. Flow (RTOR)		136
Link Speed (mph)	40	
Link Distance (ft)	291	
Travel Time (s)	5.0	
Peak Hour Factor	0.92	0.92
Shared Lane Traffic (%)		
Lane Group Flow (vph)	893	160
Turn Type	NA	Perm
Protected Phases	6	
Permitted Phases		6
Total Split (s)	35.0	35.0
Total Lost Time (s)	4.5	4.5
Act Effct Green (s)	30.5	30.5
Actuated g/C Ratio	0.25	0.25
v/c Ratio	0.99	0.32
Control Delay	73.3	10.4
Queue Delay	0.0	0.0
Total Delay	73.3	10.4
LOS	E	B
Approach Delay	69.7	
Approach LOS	E	
Queue Length 50th (ft)	364	14
Queue Length 95th (ft)	#505	70
Internal Link Dist (ft)	211	
Turn Bay Length (ft)		175
Base Capacity (vph)	899	503
Starvation Cap Reductn	0	0
Spillback Cap Reductn	0	0
Storage Cap Reductn	0	0
Reduced v/c Ratio	0.99	0.32
<b>Intersection Summary</b>		

Lanes, Volumes, Timings  
 3: Lemon Street & Orangethorpe Avenue

05/27/2021

Intersection Capacity Utilization 100.5%      ICU Level of Service G

Analysis Period (min) 15

~ Volume exceeds capacity, queue is theoretically infinite.

Queue shown is maximum after two cycles.

# 95th percentile volume exceeds capacity, queue may be longer.





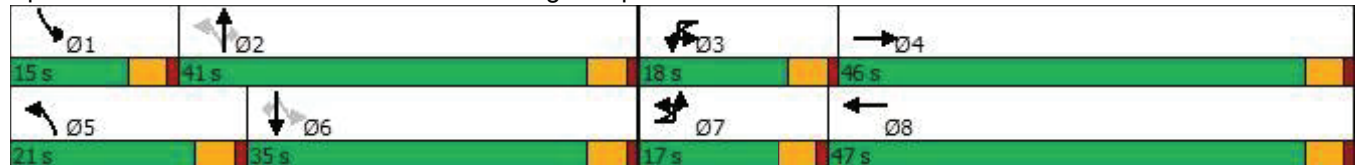













Queue shown is maximum after two cycles.

Splits and Phases: 3: Lemon Street & Orangethorpe Avenue



Lanes, Volumes, Timings  
 4: Lemon Street & South Project Access

05/27/2021

												
Lane Group	EBL	EBT	EBR	WBL	WBT	WBR	NBL	NBT	NBR	SBL	SBT	SBR
Lane Configurations												
Traffic Volume (vph)	11	2	76	27	1	27	13	1328	42	17	1056	20
Future Volume (vph)	11	2	76	27	1	27	13	1328	42	17	1056	20
Ideal Flow (vphpl)	1900	1900	1900	1900	1900	1900	1800	1900	1900	1800	1900	1900
Storage Length (ft)	0		0	0		0	20		0	50		0
Storage Lanes	0		0	0		1	1		0	1		0
Taper Length (ft)	25			25			25			25		
Satd. Flow (prot)	0	1637	0	0	1777	1583	1676	3522	0	1676	3529	0
Flt Permitted		0.994			0.954		0.950			0.950		
Satd. Flow (perm)	0	1637	0	0	1777	1583	1676	3522	0	1676	3529	0
Link Speed (mph)		25			30			40			40	
Link Distance (ft)		267			71			291			254	
Travel Time (s)		7.3			1.6			5.0			4.3	
Peak Hour Factor	0.92	0.92	0.92	0.92	0.92	0.92	0.92	0.92	0.92	0.92	0.92	0.92
Shared Lane Traffic (%)												
Lane Group Flow (vph)	0	97	0	0	30	29	14	1489	0	18	1170	0
Sign Control		Stop			Stop			Free			Free	
<b>Intersection Summary</b>												
Area Type:	Other											
Control Type:	Unsignalized											
Intersection Capacity Utilization	56.8%						ICU Level of Service B					
Analysis Period (min)	15											



HCM 6th TWSC  
4: Lemon Street & South Project Access

05/27/2021

Intersection												
Int Delay, s/veh	9.3											
Movement	EBL	EBT	EBR	WBL	WBT	WBR	NBL	NBT	NBR	SBL	SBT	SBR
Lane Configurations		↕			↕	↕	↕	↕		↕	↕	
Traffic Vol, veh/h	11	2	76	27	1	27	13	1328	42	17	1056	20
Future Vol, veh/h	11	2	76	27	1	27	13	1328	42	17	1056	20
Conflicting Peds, #/hr	0	0	0	0	0	0	0	0	0	0	0	0
Sign Control	Stop	Stop	Stop	Stop	Stop	Stop	Free	Free	Free	Free	Free	Free
RT Channelized	-	-	None	-	-	None	-	-	None	-	-	None
Storage Length	-	-	-	-	-	0	20	-	-	50	-	-
Veh in Median Storage, #	0	-	-	0	-	-	0	-	-	0	-	-
Grade, %	-	0	-	-	0	-	-	0	-	-	0	-
Peak Hour Factor	92	92	92	92	92	92	92	92	92	92	92	92
Heavy Vehicles, %	2	2	2	2	2	2	2	2	2	2	2	2
Mvmt Flow	12	2	83	29	1	29	14	1443	46	18	1148	22

Major/Minor	Minor2		Minor1		Major1		Major2					
Conflicting Flow All	1945	2712	585	2105	2700	745	1170	0	0	1489	0	0
Stage 1	1195	1195	-	1494	1494	-	-	-	-	-	-	-
Stage 2	750	1517	-	611	1206	-	-	-	-	-	-	-
Critical Hdwy	7.54	6.54	6.94	7.54	6.54	6.94	4.14	-	-	4.14	-	-
Critical Hdwy Stg 1	6.54	5.54	-	6.54	5.54	-	-	-	-	-	-	-
Critical Hdwy Stg 2	6.54	5.54	-	6.54	5.54	-	-	-	-	-	-	-
Follow-up Hdwy	3.52	4.02	3.32	3.52	4.02	3.32	2.22	-	-	2.22	-	-
Pot Cap-1 Maneuver	39	21	454	~ 29	21	357	593	-	-	447	-	-
Stage 1	198	258	-	129	185	-	-	-	-	-	-	-
Stage 2	369	180	-	448	255	-	-	-	-	-	-	-
Platoon blocked, %								-	-	-	-	-
Mov Cap-1 Maneuver	33	20	454	~ 21	20	357	593	-	-	447	-	-
Mov Cap-2 Maneuver	33	20	-	~ 21	20	-	-	-	-	-	-	-
Stage 1	193	248	-	126	181	-	-	-	-	-	-	-
Stage 2	329	176	-	349	245	-	-	-	-	-	-	-

Approach	EB	WB	NB	SB
HCM Control Delay, s	66.4	\$ 327	0.1	0.2
HCM LOS	F	F		

Minor Lane/Major Mvmt	NBL	NBT	NBR	EBLn1	WBLn1	WBLn2	SBL	SBT	SBR
Capacity (veh/h)	593	-	-	148	21	357	447	-	-
HCM Lane V/C Ratio	0.024	-	-	0.654	1.449	0.082	0.041	-	-
HCM Control Delay (s)	11.2	-	-	66.4	626.8	16	13.4	-	-
HCM Lane LOS	B	-	-	F	F	C	B	-	-
HCM 95th %tile Q(veh)	0.1	-	-	3.6	4	0.3	0.1	-	-

Notes  
 ~: Volume exceeds capacity    \$: Delay exceeds 300s    +: Computation Not Defined    \*: All major volume in platoon

Lanes, Volumes, Timings

5: Lemon Street & North Project Access/Liberty Avenue

05/27/2021



Lane Group	EBL	EBT	EBR	WBL	WBT	WBR	NBL	NBT	NBR	SBL	SBT	SBR
Lane Configurations		↔	↔		↔		↔	↔		↔	↔	
Traffic Volume (vph)	62	0	94	36	1	23	127	1223	11	1	946	72
Future Volume (vph)	62	0	94	36	1	23	127	1223	11	1	946	72
Ideal Flow (vphpl)	1900	1900	1900	1900	1900	1900	1800	1900	1900	1800	1900	1900
Storage Length (ft)	0		0	0		0	50		0	50		0
Storage Lanes	0		1	0		0	1		0	1		0
Taper Length (ft)	25			25			25			25		
Satd. Flow (prot)	0	1770	1583	0	1715	0	1676	3536	0	1676	3500	0
Flt Permitted		0.950			0.971		0.950			0.950		
Satd. Flow (perm)	0	1770	1583	0	1715	0	1676	3536	0	1676	3500	0
Link Speed (mph)		30			25			40			40	
Link Distance (ft)		333			454			254			394	
Travel Time (s)		7.6			12.4			4.3			6.7	
Peak Hour Factor	0.92	0.92	0.92	0.92	0.92	0.92	0.92	0.92	0.92	0.92	0.92	0.92
Shared Lane Traffic (%)												
Lane Group Flow (vph)	0	67	102	0	65	0	138	1341	0	1	1106	0
Sign Control		Stop			Stop			Free			Free	

Intersection Summary

Area Type:	Other
Control Type:	Unsignalized
Intersection Capacity Utilization	57.6%
	ICU Level of Service B
Analysis Period (min)	15

HCM 6th TWSC  
 5: Lemon Street & North Project Access/Liberty Avenue

05/27/2021

Intersection

Int Delay, s/veh 46.9

Movement	EBL	EBT	EBR	WBL	WBT	WBR	NBL	NBT	NBR	SBL	SBT	SBR
Lane Configurations		↑	↑		↑		↑	↑		↑	↑	
Traffic Vol, veh/h	62	0	94	36	1	23	127	1223	11	1	946	72
Future Vol, veh/h	62	0	94	36	1	23	127	1223	11	1	946	72
Conflicting Peds, #/hr	0	0	0	0	0	0	0	0	0	0	0	0
Sign Control	Stop	Stop	Stop	Stop	Stop	Stop	Free	Free	Free	Free	Free	Free
RT Channelized	-	-	None	-	-	None	-	-	None	-	-	None
Storage Length	-	-	0	-	-	-	50	-	-	50	-	-
Veh in Median Storage, #	0	-	-	0	-	-	-	0	-	-	0	-
Grade, %	-	0	-	-	0	-	-	0	-	-	0	-
Peak Hour Factor	92	92	92	92	92	92	92	92	92	92	92	92
Heavy Vehicles, %	2	2	2	2	2	2	2	2	2	2	2	2
Mvmt Flow	67	0	102	39	1	25	138	1329	12	1	1028	78

Major/Minor	Minor2	Minor1		Major1		Major2	
Conflicting Flow All2010	2686	553	2127	2719	671	1106	0
Stage 1	1069	1069	-	1611	1611	-	-
Stage 2	941	1617	-	516	1108	-	-
Critical Hdwy	7.54	6.54	6.94	7.54	6.54	6.94	4.14
Critical Hdwy Stg 1	6.54	5.54	-	6.54	5.54	-	-
Critical Hdwy Stg 2	6.54	5.54	-	6.54	5.54	-	-
Follow-up Hdwy	3.52	4.02	3.32	3.52	4.02	3.32	2.22
Pot Cap-1 Maneuver	35	21	477	~ 28	20	399	627
Stage 1	236	296	-	109	162	-	-
Stage 2	283	161	-	510	284	-	-
Platoon blocked, %							
Mov Cap-1 Maneuver	26	16	477	~ 18	16	399	627
Mov Cap-2 Maneuver	26	16	-	~ 18	16	-	-
Stage 1	184	295	-	85	126	-	-
Stage 2	205	126	-	400	283	-	-

Approach	EB	WB	NB	SB
HCM Control Delay, s	42.1	\$ 906.1	1.2	0
HCM LOS	F	F		

Minor Lane/Major Mvmt	NBL	NBT	NBR	EBLn	EBLn1	WBLn	SBL	SBT	SBR
Capacity (veh/h)	627	-	-	26	477	28	510	-	-
HCM Lane V/C Ratio	0.22	-	-	2.592	0.214	2.329	0.002	-	-
HCM Control Delay (s)	12.4	-	-	\$ 1040	14.5	\$ 906.1	12.1	-	-
HCM Lane LOS	B	-	-	F	B	F	B	-	-
HCM 95th %tile Q(veh)	0.8	-	-	8.2	0.8	7.8	0	-	-

Notes  
 ~: Volume exceeds capacity    \$: Delay exceeds 300s    +: Computation Not Defined    \*: All major volume in platoon

Lanes, Volumes, Timings  
 1: Harbor Boulevard & Orangethorpe Avenue

05/28/2021



Lane Group	EBL	EBT	EBR	WBU	WBL	WBT	WBR	NBL	NBT	NBR	SBU	SBL
Lane Configurations	↔	↑↑↑	↔		↔	↑↑↑	↔	↔	↑↑	↔		↔
Traffic Volume (vph)	195	861	211	3	167	507	175	116	1252	199	5	200
Future Volume (vph)	195	861	211	3	167	507	175	116	1252	199	5	200
Ideal Flow (vphpl)	1800	1900	1900	1800	1800	1900	1900	1750	1900	1900	1750	1750
Storage Length (ft)	200		130		240		140	120		250		270
Storage Lanes	1		1		1		1	2		0		2
Taper Length (ft)	90				60			90				100
Satd. Flow (prot)	1676	5085	1583	0	1676	5085	1583	3162	3539	1583	0	3162
Flt Permitted	0.950				0.950			0.950				0.950
Satd. Flow (perm)	1676	5085	1583	0	1676	5085	1583	3162	3539	1583	0	3162
Right Turn on Red			Yes				Yes			Yes		
Satd. Flow (RTOR)			168				190			180		
Link Speed (mph)		40				40			40			
Link Distance (ft)		787				701			655			
Travel Time (s)		13.4				11.9			11.2			
Peak Hour Factor	0.92	0.92	0.92	0.92	0.92	0.92	0.92	0.92	0.92	0.92	0.92	0.92
Shared Lane Traffic (%)												
Lane Group Flow (vph)	212	936	229	0	185	551	190	126	1361	216	0	222
Turn Type	Prot	NA	Perm	Prot	Prot	NA	Perm	Prot	NA	Perm	Prot	Prot
Protected Phases	7	4		3	3	8		5	2		1	1
Permitted Phases			4				8			2		
Total Split (s)	22.0	26.0	26.0	21.0	21.0	25.0	25.0	14.0	48.0	48.0	15.0	15.0
Total Lost Time (s)	4.5	4.5	4.5		4.5	4.5	4.5	4.5	4.5	4.5		4.5
Act Effct Green (s)	16.4	21.5	21.5		15.1	20.2	20.2	8.8	43.5	43.5		10.3
Actuated g/C Ratio	0.15	0.20	0.20		0.14	0.19	0.19	0.08	0.40	0.40		0.10
v/c Ratio	0.84	0.93	0.51		0.79	0.58	0.42	0.49	0.96	0.29		0.74
Control Delay	72.5	58.9	16.2		69.6	43.3	8.7	54.8	48.2	6.3		64.1
Queue Delay	0.0	0.0	0.0		0.0	0.0	0.0	0.0	0.0	0.0		0.0
Total Delay	72.5	58.9	16.2		69.6	43.3	8.7	54.8	48.2	6.3		64.1
LOS	E	E	B		E	D	A	D	D	A		E
Approach Delay		53.9				41.4			43.4			
Approach LOS		D				D			D			
Queue Length 50th (ft)	146	241	36		126	131	0	44	489	15		79
Queue Length 95th (ft)	#266	#326	112		#230	171	61	75	#648	64		#132
Internal Link Dist (ft)		707				621			575			
Turn Bay Length (ft)	200		130		240		140	120		250		270
Base Capacity (vph)	270	1008	448		255	962	453	277	1420	743		306
Starvation Cap Reductn	0	0	0		0	0	0	0	0	0		0
Spillback Cap Reductn	0	0	0		0	0	0	0	0	0		0
Storage Cap Reductn	0	0	0		0	0	0	0	0	0		0
Reduced v/c Ratio	0.79	0.93	0.51		0.73	0.57	0.42	0.45	0.96	0.29		0.73

Intersection Summary

Area Type:	Other
Cycle Length:	110
Actuated Cycle Length:	108.4
Control Type:	Actuated-Uncoordinated
Maximum v/c Ratio:	0.96
Intersection Signal Delay:	43.9
Intersection LOS:	D

Lanes, Volumes, Timings  
 1: Harbor Boulevard & Orangethorpe Avenue

05/28/2021



Lane Group	SBT	SBR
Lane Configurations	↑↑↑	
Traffic Volume (vph)	1571	133
Future Volume (vph)	1571	133
Ideal Flow (vphpl)	1900	1900
Storage Length (ft)		160
Storage Lanes		0
Taper Length (ft)		
Satd. Flow (prot)	5024	0
Flt Permitted		
Satd. Flow (perm)	5024	0
Right Turn on Red		Yes
Satd. Flow (RTOR)	15	
Link Speed (mph)	40	
Link Distance (ft)	935	
Travel Time (s)	15.9	
Peak Hour Factor	0.92	0.92
Shared Lane Traffic (%)		
Lane Group Flow (vph)	1853	0
Turn Type	NA	
Protected Phases	6	
Permitted Phases		
Total Split (s)	49.0	
Total Lost Time (s)	4.5	
Act Effct Green (s)	45.0	
Actuated g/C Ratio	0.42	
v/c Ratio	0.88	
Control Delay	35.7	
Queue Delay	0.0	
Total Delay	35.7	
LOS	D	
Approach Delay	38.7	
Approach LOS	D	
Queue Length 50th (ft)	440	
Queue Length 95th (ft)	512	
Internal Link Dist (ft)	855	
Turn Bay Length (ft)		
Base Capacity (vph)	2095	
Starvation Cap Reductn	0	
Spillback Cap Reductn	0	
Storage Cap Reductn	0	
Reduced v/c Ratio	0.88	
<b>Intersection Summary</b>		

Lanes, Volumes, Timings  
 1: Harbor Boulevard & Orangethorpe Avenue

05/28/2021

Intersection Capacity Utilization 82.5%      ICU Level of Service E

Analysis Period (min) 15

# 95th percentile volume exceeds capacity, queue may be longer.

Queue shown is maximum after two cycles.

Splits and Phases: 1: Harbor Boulevard & Orangethorpe Avenue



Lanes, Volumes, Timings  
2: Pomona Avenue & Orangethorpe Avenue

05/28/2021



Lane Group	EBU	EBL	EBT	EBR	WBU	WBL	WBT	WBR	NBL	NBT	NBR	SBL
Lane Configurations		↔	↑↑↑				↔	↑↑	↗	↖	↔	↗
Traffic Volume (vph)	2	107	1231	53	21	24	729	95	58	19	29	93
Future Volume (vph)	2	107	1231	53	21	24	729	95	58	19	29	93
Ideal Flow (vphpl)	1800	1800	1900	1900	1800	1800	1900	1900	1800	1900	1900	1800
Storage Length (ft)		140		0		150		70	95		0	70
Storage Lanes		1		0		1		1	1		0	1
Taper Length (ft)		60				70			30			60
Satd. Flow (prot)	0	1676	5055	0	0	1676	3539	1583	1676	1693	0	1676
Flt Permitted		0.348				0.169			0.687			0.722
Satd. Flow (perm)	0	614	5055	0	0	298	3539	1583	1212	1693	0	1274
Right Turn on Red				Yes				Yes			Yes	
Satd. Flow (RTOR)			22					103		32		
Link Speed (mph)			40				40			25		
Link Distance (ft)			701				647			214		
Travel Time (s)			11.9				11.0			5.8		
Peak Hour Factor	0.92	0.92	0.92	0.92	0.92	0.92	0.92	0.92	0.92	0.92	0.92	0.92
Shared Lane Traffic (%)												
Lane Group Flow (vph)	0	118	1396	0	0	49	792	103	63	53	0	101
Turn Type	Perm	Perm	NA		Perm	Perm	NA	Perm	Perm	NA		Perm
Protected Phases			4				8			2		
Permitted Phases	4	4			8	8		8	2			6
Total Split (s)	39.0	39.0	39.0		39.0	39.0	39.0	39.0	16.0	16.0		16.0
Total Lost Time (s)		4.5	4.5				4.5	4.5	4.5	4.5		4.5
Act Effct Green (s)		27.8	27.8				27.8	27.8	27.8	8.5	8.5	8.5
Actuated g/C Ratio		0.67	0.67				0.67	0.67	0.67	0.20	0.20	0.20
v/c Ratio		0.29	0.41				0.25	0.34	0.09	0.26	0.14	0.39
Control Delay		7.2	5.0				8.6	4.9	1.4	19.0	10.7	21.3
Queue Delay		0.0	0.0				0.0	0.0	0.0	0.0	0.0	0.0
Total Delay		7.2	5.0				8.6	4.9	1.4	19.0	10.7	21.3
LOS		A	A				A	A	A	B	B	C
Approach Delay			5.2				4.7			15.2		
Approach LOS			A				A			B		
Queue Length 50th (ft)		12	54				5	42	0	12	4	19
Queue Length 95th (ft)		39	93				23	79	12	45	29	66
Internal Link Dist (ft)			621				567			134		
Turn Bay Length (ft)		140				150		70	95			70
Base Capacity (vph)		512	4225			248	2955	1339	349	511		368
Starvation Cap Reductn		0	0			0	0	0	0	0		0
Spillback Cap Reductn		0	0			0	0	0	0	0		0
Storage Cap Reductn		0	0			0	0	0	0	0		0
Reduced v/c Ratio		0.23	0.33			0.20	0.27	0.08	0.18	0.10		0.27

Intersection Summary

Area Type:	Other
Cycle Length:	55
Actuated Cycle Length:	41.6
Control Type:	Actuated-Uncoordinated
Maximum v/c Ratio:	0.41
Intersection Signal Delay:	6.1
Intersection LOS:	A



Lanes, Volumes, Timings  
 2: Pomona Avenue & Orangethorpe Avenue

05/28/2021



Lane Group	SBT	SBR
Lane Configurations	7	93
Traffic Volume (vph)	7	93
Future Volume (vph)	7	93
Ideal Flow (vphpl)	1900	1900
Storage Length (ft)		0
Storage Lanes		0
Taper Length (ft)		
Satd. Flow (prot)	1604	0
Flt Permitted		
Satd. Flow (perm)	1604	0
Right Turn on Red		Yes
Satd. Flow (RTOR)	101	
Link Speed (mph)	25	
Link Distance (ft)	398	
Travel Time (s)	10.9	
Peak Hour Factor	0.92	0.92
Shared Lane Traffic (%)		
Lane Group Flow (vph)	109	0
Turn Type	NA	
Protected Phases	6	
Permitted Phases		
Total Split (s)	16.0	
Total Lost Time (s)	4.5	
Act Effct Green (s)	8.5	
Actuated g/C Ratio	0.20	
v/c Ratio	0.27	
Control Delay	7.3	
Queue Delay	0.0	
Total Delay	7.3	
LOS	A	
Approach Delay	14.0	
Approach LOS	B	
Queue Length 50th (ft)	1	
Queue Length 95th (ft)	34	
Internal Link Dist (ft)	318	
Turn Bay Length (ft)		
Base Capacity (vph)	535	
Starvation Cap Reductn	0	
Spillback Cap Reductn	0	
Storage Cap Reductn	0	
Reduced v/c Ratio	0.20	
Intersection Summary		

Lanes, Volumes, Timings  
2: Pomona Avenue & Orangethorpe Avenue

05/28/2021

Intersection Capacity Utilization 52.5%      ICU Level of Service A  
Analysis Period (min) 15

Splits and Phases: 2: Pomona Avenue & Orangethorpe Avenue

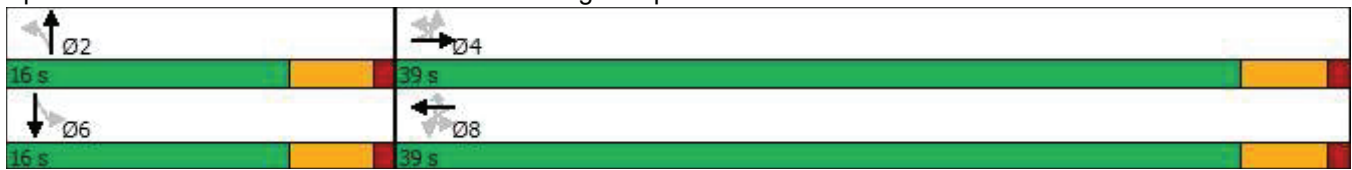

Lanes, Volumes, Timings  
3: Lemon Street & Orangethorpe Avenue

05/28/2021



Lane Group	EBU	EBL	EBT	EBR	WBL	WBT	WBR	NBL	NBT	NBR	SBL	SBT
Lane Configurations		↔	↑↑↑		↔	↑↑		↔	↑↑	↔	↔	↑↑
Traffic Volume (vph)	2	87	1081	233	154	596	117	256	785	231	224	878
Future Volume (vph)	2	87	1081	233	154	596	117	256	785	231	224	878
Ideal Flow (vphpl)	1800	1800	1900	1900	1750	1900	1900	1800	1900	1900	1800	1900
Storage Length (ft)		140		0	170		0	200		130	145	
Storage Lanes		1		0	2		0	1		1	1	
Taper Length (ft)		115			120			90			105	
Satd. Flow (prot)	0	1676	4948	0	3162	3451	0	1676	3539	1583	1676	3539
Flt Permitted		0.950			0.950			0.116			0.152	
Satd. Flow (perm)	0	1676	4948	0	3162	3451	0	205	3539	1583	268	3539
Right Turn on Red				Yes			Yes			Yes		
Satd. Flow (RTOR)			45			21				167		
Link Speed (mph)			40			40			40			40
Link Distance (ft)			647			477			670			291
Travel Time (s)			11.0			8.1			11.4			5.0
Peak Hour Factor	0.92	0.92	0.92	0.92	0.92	0.92	0.92	0.92	0.92	0.92	0.92	0.92
Shared Lane Traffic (%)												
Lane Group Flow (vph)	0	97	1428	0	167	775	0	278	853	251	243	954
Turn Type	Prot	Prot	NA		Prot	NA		pm+pt	NA	Perm	pm+pt	NA
Protected Phases	7	7	4		3	8		5	2		1	6
Permitted Phases								2		2		6
Total Split (s)	15.0	15.0	39.0		13.0	37.0		21.0	40.0	40.0	18.0	37.0
Total Lost Time (s)		4.5	4.5		4.5	4.5		4.5	4.5	4.5	4.5	4.5
Act Effct Green (s)		9.7	34.1		8.4	32.8		50.7	34.6	34.6	44.9	31.8
Actuated g/C Ratio		0.09	0.31		0.08	0.30		0.47	0.32	0.32	0.41	0.29
v/c Ratio		0.65	0.90		0.68	0.73		0.89	0.75	0.41	0.86	0.92
Control Delay		68.8	43.4		64.1	38.1		56.8	38.1	12.1	52.5	51.9
Queue Delay		0.0	0.0		0.0	0.0		0.0	0.0	0.0	0.0	0.0
Total Delay		68.8	43.4		64.1	38.1		56.8	38.1	12.1	52.5	51.9
LOS		E	D		E	D		E	D	B	D	D
Approach Delay			45.0			42.7			37.1			48.7
Approach LOS			D			D			D			D
Queue Length 50th (ft)		67	342		60	253		142	281	42	107	341
Queue Length 95th (ft)		#134	#417		#104	325		#295	356	110	#249	#463
Internal Link Dist (ft)			567			397			590			211
Turn Bay Length (ft)		140			170			200		130	145	
Base Capacity (vph)		162	1608		248	1059		321	1161	631	287	1063
Starvation Cap Reductn		0	0		0	0		0	0	0	0	0
Spillback Cap Reductn		0	0		0	0		0	0	0	0	0
Storage Cap Reductn		0	0		0	0		0	0	0	0	0
Reduced v/c Ratio		0.60	0.89		0.67	0.73		0.87	0.73	0.40	0.85	0.90

Intersection Summary

Area Type:	Other
Cycle Length:	110
Actuated Cycle Length:	108.3
Control Type:	Actuated-Uncoordinated
Maximum v/c Ratio:	0.92
Intersection Signal Delay:	43.4
Intersection LOS:	D

Lanes, Volumes, Timings  
 3: Lemon Street & Orangethorpe Avenue

05/28/2021

Lane Group	SBR
Lane Configurations	
Traffic Volume (vph)	84
Future Volume (vph)	84
Ideal Flow (vphpl)	1900
Storage Length (ft)	175
Storage Lanes	1
Taper Length (ft)	
Satd. Flow (prot)	1583
Flt Permitted	
Satd. Flow (perm)	1583
Right Turn on Red	Yes
Satd. Flow (RTOR)	104
Link Speed (mph)	
Link Distance (ft)	
Travel Time (s)	
Peak Hour Factor	0.92
Shared Lane Traffic (%)	
Lane Group Flow (vph)	91
Turn Type	Perm
Protected Phases	
Permitted Phases	6
Total Split (s)	37.0
Total Lost Time (s)	4.5
Act Effct Green (s)	31.8
Actuated g/C Ratio	0.29
v/c Ratio	0.17
Control Delay	5.2
Queue Delay	0.0
Total Delay	5.2
LOS	A
Approach Delay	
Approach LOS	
Queue Length 50th (ft)	0
Queue Length 95th (ft)	31
Internal Link Dist (ft)	
Turn Bay Length (ft)	175
Base Capacity (vph)	548
Starvation Cap Reductn	0
Spillback Cap Reductn	0
Storage Cap Reductn	0
Reduced v/c Ratio	0.17
<b>Intersection Summary</b>	

Lanes, Volumes, Timings  
 3: Lemon Street & Orangethorpe Avenue

05/28/2021

Intersection Capacity Utilization 85.1%      ICU Level of Service E

Analysis Period (min) 15

# 95th percentile volume exceeds capacity, queue may be longer.





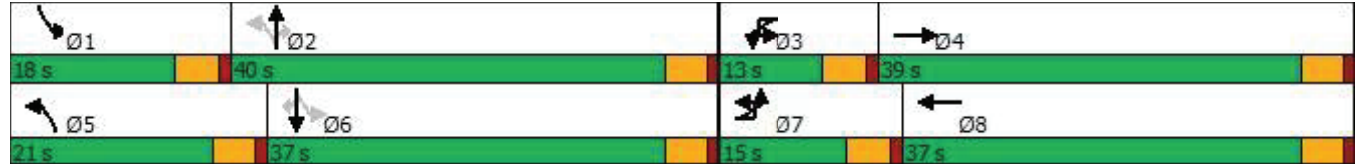













Queue shown is maximum after two cycles.

Splits and Phases: 3: Lemon Street & Orangethorpe Avenue



Lanes, Volumes, Timings  
 4: Lemon Street & South Project Access

05/28/2021

												
Lane Group	EBL	EBT	EBR	WBL	WBT	WBR	NBL	NBT	NBR	SBL	SBT	SBR
Lane Configurations								 			 	
Traffic Volume (vph)	0	0	55	0	0	4	0	987	4	0	1150	30
Future Volume (vph)	0	0	55	0	0	4	0	987	4	0	1150	30
Ideal Flow (vphpl)	1900	1900	1900	1900	1900	1900	1800	1900	1900	1800	1900	1900
Storage Length (ft)	0		0	0		0	20		0	50		0
Storage Lanes	0		1	0		1	0		0	0		0
Taper Length (ft)	25			25			25			25		
Satd. Flow (prot)	0	0	1611	0	0	1611	0	3536	0	0	3525	0
Flt Permitted												
Satd. Flow (perm)	0	0	1611	0	0	1611	0	3536	0	0	3525	0
Link Speed (mph)		25			30			40			40	
Link Distance (ft)		267			71			291			254	
Travel Time (s)		7.3			1.6			5.0			4.3	
Peak Hour Factor	0.92	0.92	0.92	0.92	0.92	0.92	0.92	0.92	0.92	0.92	0.92	0.92
Shared Lane Traffic (%)												
Lane Group Flow (vph)	0	0	60	0	0	4	0	1077	0	0	1283	0
Sign Control		Stop			Stop			Free			Free	
<b>Intersection Summary</b>												
Area Type:	Other											
Control Type:	Unsignalized											
Intersection Capacity Utilization	42.8%						ICU Level of Service A					
Analysis Period (min)	15											

HCM 6th TWSC  
4: Lemon Street & South Project Access

05/28/2021

Intersection												
Int Delay, s/veh	0.4											
Movement	EBL	EBT	EBR	WBL	WBT	WBR	NBL	NBT	NBR	SBL	SBT	SBR
Lane Configurations			↑			↑		↑↓			↑↓	
Traffic Vol, veh/h	0	0	55	0	0	4	0	987	4	0	1150	30
Future Vol, veh/h	0	0	55	0	0	4	0	987	4	0	1150	30
Conflicting Peds, #/hr	0	0	0	0	0	0	0	0	0	0	0	0
Sign Control	Stop	Stop	Stop	Stop	Stop	Stop	Free	Free	Free	Free	Free	Free
RT Channelized	-	-	None	-	-	None	-	-	None	-	-	None
Storage Length	-	-	0	-	-	0	-	-	-	-	-	-
Veh in Median Storage,-#	0	-	-	0	-	-	0	-	-	0	-	-
Grade, %	-	0	-	-	0	-	-	0	-	-	0	-
Peak Hour Factor	92	92	92	92	92	92	92	92	92	92	92	92
Heavy Vehicles, %	2	2	2	2	2	2	2	2	2	2	2	2
Mvmt Flow	0	0	60	0	0	4	0	1073	4	0	1250	33

Major/Minor	Minor2	Minor1	Major1	Major2								
Conflicting Flow All	-	-	642	-	-	539	-	0	0	-	-	0
Stage 1	-	-	-	-	-	-	-	-	-	-	-	-
Stage 2	-	-	-	-	-	-	-	-	-	-	-	-
Critical Hdwy	-	-	6.94	-	-	6.94	-	-	-	-	-	-
Critical Hdwy Stg 1	-	-	-	-	-	-	-	-	-	-	-	-
Critical Hdwy Stg 2	-	-	-	-	-	-	-	-	-	-	-	-
Follow-up Hdwy	-	-	3.32	-	-	3.32	-	-	-	-	-	-
Pot Cap-1 Maneuver	0	0	417	0	0	487	0	-	-	0	-	-
Stage 1	0	0	-	0	0	-	0	-	-	0	-	-
Stage 2	0	0	-	0	0	-	0	-	-	0	-	-
Platoon blocked, %								-	-	-	-	-
Mov Cap-1 Maneuver	-	-	417	-	-	487	-	-	-	-	-	-
Mov Cap-2 Maneuver	-	-	-	-	-	-	-	-	-	-	-	-
Stage 1	-	-	-	-	-	-	-	-	-	-	-	-
Stage 2	-	-	-	-	-	-	-	-	-	-	-	-

Approach	EB	WB	NB	SB
HCM Control Delay, s	15.1	12.5	0	0
HCM LOS	C	B		

Minor Lane/Major Mvmt	NBT	NBR	EBLn	WBLn1	SBT	SBR
Capacity (veh/h)	-	-	417	487	-	-
HCM Lane V/C Ratio	-	-	0.143	0.009	-	-
HCM Control Delay (s)	-	-	15.1	12.5	-	-
HCM Lane LOS	-	-	C	B	-	-
HCM 95th %tile Q(veh)	-	-	0.5	0	-	-



Lanes, Volumes, Timings  
 5: Lemon Street & North Project Access/Liberty Avenue

08/17/2021



Lane Group	EBL	EBT	EBR	WBL	WBT	WBR	NBL	NBT	NBR	SBL	SBT	SBR
Lane Configurations		↕	↗		↔		↖	↕↔		↖	↕↕	↗
Traffic Volume (vph)	37	0	77	54	2	12	34	827	98	30	1048	21
Future Volume (vph)	37	0	77	54	2	12	34	827	98	30	1048	21
Ideal Flow (vphpl)	1900	1900	1900	1900	1900	1900	1800	1900	1900	1800	1900	1900
Storage Length (ft)	0		0	0		0	50		0	50		0
Storage Lanes	0		1	0		0	1		0	1		1
Taper Length (ft)	25			25			25			25		
Satd. Flow (prot)	0	1770	1583	0	1749	0	1676	3483	0	1676	3539	1583
Flt Permitted		0.950			0.962		0.170			0.229		
Satd. Flow (perm)	0	1770	1583	0	1749	0	300	3483	0	404	3539	1583
Right Turn on Red			Yes			Yes			Yes			Yes
Satd. Flow (RTOR)			127		10			18				127
Link Speed (mph)		30			25			40				40
Link Distance (ft)		333			454			254				394
Travel Time (s)		7.6			12.4			4.3				6.7
Peak Hour Factor	0.92	0.92	0.92	0.92	0.92	0.92	0.92	0.92	0.92	0.92	0.92	0.92
Shared Lane Traffic (%)												
Lane Group Flow (vph)	0	40	84	0	74	0	37	1006	0	33	1139	23
Turn Type	Split	NA	Perm	Split	NA		pm+pt	NA		pm+pt	NA	Perm
Protected Phases	4	4		8	8		5	2		1	6	
Permitted Phases			4				2			6		6
Total Split (s)	18.0	18.0	18.0	18.0	18.0		10.0	44.0		10.0	44.0	44.0
Total Lost Time (s)		4.5	4.5		4.5		4.5	4.5		4.5	4.5	4.5
Act Effct Green (s)		7.8	7.8		8.7		38.5	38.7		37.7	37.0	37.0
Actuated g/C Ratio		0.13	0.13		0.14		0.63	0.64		0.62	0.61	0.61
v/c Ratio		0.18	0.27		0.29		0.11	0.45		0.09	0.53	0.02
Control Delay		33.5	4.9		29.9		7.6	11.4		7.4	13.9	0.0
Queue Delay		0.0	0.0		0.0		0.0	0.0		0.0	0.0	0.0
Total Delay		33.5	4.9		29.9		7.6	11.4		7.4	13.9	0.0
LOS		C	A		C		A	B		A	B	A
Approach Delay		14.1			29.9			11.3			13.4	
Approach LOS		B			C			B			B	
Queue Length 50th (ft)		16	0		25		6	114		5	201	0
Queue Length 95th (ft)		49	18		70		20	260		18	311	0
Internal Link Dist (ft)		253			374			174			314	
Turn Bay Length (ft)							50			50		
Base Capacity (vph)		457	502		459		334	2410		384	2435	1128
Starvation Cap Reductn		0	0		0		0	0		0	0	0
Spillback Cap Reductn		0	0		0		0	0		0	0	0
Storage Cap Reductn		0	0		0		0	0		0	0	0
Reduced v/c Ratio		0.09	0.17		0.16		0.11	0.42		0.09	0.47	0.02

Intersection Summary

Area Type: Other  
 Cycle Length: 90  
 Actuated Cycle Length: 60.9  
 Control Type: Actuated-Uncoordinated  
 Maximum v/c Ratio: 0.53  
 Intersection Signal Delay: 13.0                      Intersection LOS: B

Lanes, Volumes, Timings

5: Lemon Street & North Project Access/Liberty Avenue

08/17/2021

Intersection Capacity Utilization 49.2%

ICU Level of Service A

Analysis Period (min) 15

Splits and Phases: 5: Lemon Street & North Project Access/Liberty Avenue

 Ø1	 Ø2	 Ø4	 Ø8
10 s	44 s	18 s	18 s
 Ø5	 Ø6		
10 s	44 s		

Lanes, Volumes, Timings  
1: Harbor Boulevard & Orangethorpe Avenue

05/28/2021



Lane Group	EBU	EBL	EBT	EBR	WBU	WBL	WBT	WBR	NBU	NBL	NBT	NBR
Lane Configurations		↔	↔↔↔	↔		↔	↔↔↔	↔		↔↔	↔↔	↔
Traffic Volume (vph)	2	249	832	190	16	245	996	206	1	245	1292	245
Future Volume (vph)	2	249	832	190	16	245	996	206	1	245	1292	245
Ideal Flow (vphpl)	1800	1800	1900	1900	1800	1800	1900	1900	1750	1750	1900	1900
Storage Length (ft)		200		130		240		140		120		250
Storage Lanes		1		1		1		1		2		0
Taper Length (ft)		90				60				90		
Satd. Flow (prot)	0	1676	5085	1583	0	1676	5085	1583	0	3162	3539	1583
Flt Permitted		0.950				0.950				0.950		
Satd. Flow (perm)	0	1676	5085	1583	0	1676	5085	1583	0	3162	3539	1583
Right Turn on Red				Yes				Yes				Yes
Satd. Flow (RTOR)				149				145				194
Link Speed (mph)			40				40				40	
Link Distance (ft)			787				701				655	
Travel Time (s)			13.4				11.9				11.2	
Peak Hour Factor	0.92	0.92	0.92	0.92	0.92	0.92	0.92	0.92	0.92	0.92	0.92	0.92
Shared Lane Traffic (%)												
Lane Group Flow (vph)	0	273	904	207	0	283	1083	224	0	267	1404	266
Turn Type	Prot	Prot	NA	Perm	Prot	Prot	NA	Perm	Prot	Prot	NA	Perm
Protected Phases	7	7	4		3	3	8		5	5	2	
Permitted Phases				4				8				2
Total Split (s)	23.0	23.0	31.0	31.0	24.0	24.0	32.0	32.0	17.0	17.0	51.0	51.0
Total Lost Time (s)		4.5	4.5	4.5		4.5	4.5	4.5		4.5	4.5	4.5
Act Effct Green (s)		18.5	26.5	26.5		19.5	27.5	27.5		12.3	46.5	46.5
Actuated g/C Ratio		0.15	0.22	0.22		0.16	0.23	0.23		0.10	0.39	0.39
v/c Ratio		1.06	0.81	0.45		1.04	0.93	0.47		0.82	1.02	0.36
Control Delay		120.9	50.8	15.8		114.5	59.7	18.1		73.7	67.2	9.0
Queue Delay		0.0	0.0	0.0		0.0	0.0	0.0		0.0	0.0	0.0
Total Delay		120.9	50.8	15.8		114.5	59.7	18.1		73.7	67.2	9.0
LOS		F	D	B		F	E	B		E	E	A
Approach Delay			59.4				63.6				60.1	
Approach LOS			E				E				E	
Queue Length 50th (ft)		~232	244	37		~237	302	50		106	~609	35
Queue Length 95th (ft)		#404	297	108		#412	#389	127		#173	#748	99
Internal Link Dist (ft)			707				621				575	
Turn Bay Length (ft)		200		130		240		140		120		250
Base Capacity (vph)		258	1122	465		272	1165	474		329	1371	732
Starvation Cap Reductn		0	0	0		0	0	0		0	0	0
Spillback Cap Reductn		0	0	0		0	0	0		0	0	0
Storage Cap Reductn		0	0	0		0	0	0		0	0	0
Reduced v/c Ratio		1.06	0.81	0.45		1.04	0.93	0.47		0.81	1.02	0.36

Intersection Summary

Area Type:	Other
Cycle Length:	120
Actuated Cycle Length:	120
Control Type:	Actuated-Uncoordinated
Maximum v/c Ratio:	1.06
Intersection Signal Delay:	57.9
Intersection LOS:	E

Lanes, Volumes, Timings  
 1: Harbor Boulevard & Orangethorpe Avenue

05/28/2021



Lane Group	SBU	SBL	SBT	SBR
Lane Configurations				
Traffic Volume (vph)	13	210	1248	220
Future Volume (vph)	13	210	1248	220
Ideal Flow (vphpl)	1750	1750	1900	1900
Storage Length (ft)		270		160
Storage Lanes		2		0
Taper Length (ft)		100		
Satd. Flow (prot)	0	3162	4973	0
Flt Permitted		0.950		
Satd. Flow (perm)	0	3162	4973	0
Right Turn on Red				Yes
Satd. Flow (RTOR)			33	
Link Speed (mph)			40	
Link Distance (ft)			935	
Travel Time (s)			15.9	
Peak Hour Factor	0.92	0.92	0.92	0.92
Shared Lane Traffic (%)				
Lane Group Flow (vph)	0	242	1596	0
Turn Type	Prot	Prot	NA	
Protected Phases	1	1	6	
Permitted Phases				
Total Split (s)	14.0	14.0	48.0	
Total Lost Time (s)		4.5	4.5	
Act Effct Green (s)		9.5	43.7	
Actuated g/C Ratio		0.08	0.36	
v/c Ratio		0.97	0.87	
Control Delay		104.6	41.2	
Queue Delay		0.0	0.0	
Total Delay		104.6	41.2	
LOS		F	D	
Approach Delay			49.6	
Approach LOS			D	
Queue Length 50th (ft)		97	412	
Queue Length 95th (ft)		#181	478	
Internal Link Dist (ft)			855	
Turn Bay Length (ft)		270		
Base Capacity (vph)		250	1830	
Starvation Cap Reductn		0	0	
Spillback Cap Reductn		0	0	
Storage Cap Reductn		0	0	
Reduced v/c Ratio		0.97	0.87	
<b>Intersection Summary</b>				

# Lanes, Volumes, Timings

## 1: Harbor Boulevard & Orangethorpe Avenue

05/28/2021

Intersection Capacity Utilization 91.5%      ICU Level of Service F

Analysis Period (min) 15

~ Volume exceeds capacity, queue is theoretically infinite.

Queue shown is maximum after two cycles.

# 95th percentile volume exceeds capacity, queue may be longer.

Queue shown is maximum after two cycles.

Splits and Phases: 1: Harbor Boulevard & Orangethorpe Avenue

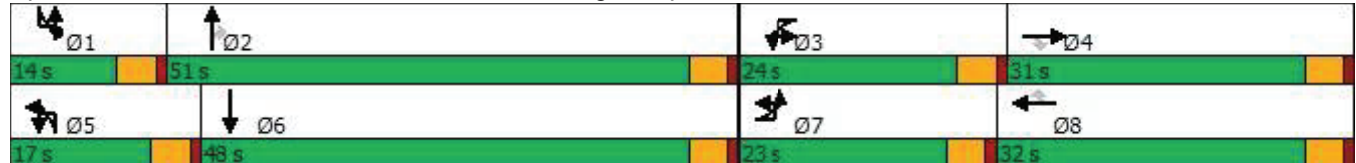

Lanes, Volumes, Timings  
2: Pomona Avenue & Orangethorpe Avenue

05/28/2021



Lane Group	EBU	EBL	EBT	EBR	WBU	WBL	WBT	WBR	NBL	NBT	NBR	SBL
Lane Configurations		↔	↑↑↑				↔	↑↑	↔	↔	↔	↔
Traffic Volume (vph)	5	186	858	85	11	53	986	174	93	40	80	157
Future Volume (vph)	5	186	858	85	11	53	986	174	93	40	80	157
Ideal Flow (vphpl)	1800	1800	1900	1900	1800	1800	1900	1900	1800	1900	1900	1800
Storage Length (ft)		140		0		150		70	95		0	70
Storage Lanes		1		0		1		1	1		0	1
Taper Length (ft)		60				70			30			60
Satd. Flow (prot)	0	1676	5019	0	0	1676	3539	1583	1676	1676	0	1676
Flt Permitted		0.232				0.262			0.654			0.674
Satd. Flow (perm)	0	409	5019	0	0	462	3539	1583	1154	1676	0	1189
Right Turn on Red				Yes				Yes			Yes	
Satd. Flow (RTOR)			57					189		87		
Link Speed (mph)			40				40			25		
Link Distance (ft)			701				647			214		
Travel Time (s)			11.9				11.0			5.8		
Peak Hour Factor	0.92	0.92	0.92	0.92	0.92	0.92	0.92	0.92	0.92	0.92	0.92	0.92
Shared Lane Traffic (%)												
Lane Group Flow (vph)	0	207	1025	0	0	70	1072	189	101	130	0	171
Turn Type	Perm	Perm	NA		Perm	Perm	NA	Perm	Perm	NA		Perm
Protected Phases			4				8			2		
Permitted Phases	4	4			8	8		8	2			6
Total Split (s)	44.0	44.0	44.0		44.0	44.0	44.0	44.0	16.0	16.0		16.0
Total Lost Time (s)		4.5	4.5				4.5	4.5	4.5	4.5		4.5
Act Effct Green (s)		35.2	35.2				35.2	35.2	35.2	10.8	10.8	10.8
Actuated g/C Ratio		0.64	0.64				0.64	0.64	0.64	0.20	0.20	0.20
v/c Ratio		0.79	0.32				0.24	0.47	0.18	0.45	0.33	0.74
Control Delay		34.2	4.5				6.6	6.0	1.1	28.2	11.9	44.5
Queue Delay		0.0	0.0				0.0	0.0	0.0	0.0	0.0	0.0
Total Delay		34.2	4.5				6.6	6.0	1.1	28.2	11.9	44.5
LOS		C	A				A	A	A	C	B	D
Approach Delay			9.5				5.3			19.0		
Approach LOS			A				A			B		
Queue Length 50th (ft)		42	44				8	81	0	33	13	59
Queue Length 95th (ft)		#168	60				25	114	15	74	53	#148
Internal Link Dist (ft)			621				567			134		
Turn Bay Length (ft)		140					150		70	95		70
Base Capacity (vph)		297	3658				335	2568	1200	244	422	250
Starvation Cap Reductn		0	0				0	0	0	0	0	0
Spillback Cap Reductn		0	0				0	0	0	0	0	0
Storage Cap Reductn		0	0				0	0	0	0	0	0
Reduced v/c Ratio		0.70	0.28				0.21	0.42	0.16	0.41	0.31	0.68

Intersection Summary

Area Type: Other

Cycle Length: 60

Actuated Cycle Length: 55.1

Control Type: Actuated-Uncoordinated

Maximum v/c Ratio: 0.79

Intersection Signal Delay: 10.4

Intersection LOS: B

Lanes, Volumes, Timings  
 2: Pomona Avenue & Orangethorpe Avenue

05/28/2021



Lane Group	SBT	SBR
Lane Configurations		
Traffic Volume (vph)	37	112
Future Volume (vph)	37	112
Ideal Flow (vphpl)	1900	1900
Storage Length (ft)		0
Storage Lanes		0
Taper Length (ft)		
Satd. Flow (prot)	1652	0
Flt Permitted		
Satd. Flow (perm)	1652	0
Right Turn on Red		Yes
Satd. Flow (RTOR)	122	
Link Speed (mph)	25	
Link Distance (ft)	398	
Travel Time (s)	10.9	
Peak Hour Factor	0.92	0.92
Shared Lane Traffic (%)		
Lane Group Flow (vph)	162	0
Turn Type	NA	
Protected Phases	6	
Permitted Phases		
Total Split (s)	16.0	
Total Lost Time (s)	4.5	
Act Effct Green (s)	10.8	
Actuated g/C Ratio	0.20	
v/c Ratio	0.38	
Control Delay	10.7	
Queue Delay	0.0	
Total Delay	10.7	
LOS	B	
Approach Delay	28.1	
Approach LOS	C	
Queue Length 50th (ft)	12	
Queue Length 95th (ft)	56	
Internal Link Dist (ft)	318	
Turn Bay Length (ft)		
Base Capacity (vph)	445	
Starvation Cap Reductn	0	
Spillback Cap Reductn	0	
Storage Cap Reductn	0	
Reduced v/c Ratio	0.36	
Intersection Summary		



Lanes, Volumes, Timings  
2: Pomona Avenue & Orangethorpe Avenue

05/28/2021

Intersection Capacity Utilization 69.6% ICU Level of Service C

Analysis Period (min) 15

# 95th percentile volume exceeds capacity, queue may be longer.

Queue shown is maximum after two cycles.

Splits and Phases: 2: Pomona Avenue & Orangethorpe Avenue





Lanes, Volumes, Timings  
 3: Lemon Street & Orangethorpe Avenue

05/28/2021



Lane Group	SBT	SBR
Lane Configurations	↑↑	↑
Traffic Volume (vph)	825	147
Future Volume (vph)	825	147
Ideal Flow (vphpl)	1900	1900
Storage Length (ft)		175
Storage Lanes		1
Taper Length (ft)		
Satd. Flow (prot)	3539	1583
Flt Permitted		
Satd. Flow (perm)	3539	1583
Right Turn on Red		Yes
Satd. Flow (RTOR)		136
Link Speed (mph)	40	
Link Distance (ft)	291	
Travel Time (s)	5.0	
Peak Hour Factor	0.92	0.92
Shared Lane Traffic (%)		
Lane Group Flow (vph)	897	160
Turn Type	NA	Perm
Protected Phases	6	
Permitted Phases		6
Total Split (s)	35.0	35.0
Total Lost Time (s)	4.5	4.5
Act Effct Green (s)	30.5	30.5
Actuated g/C Ratio	0.25	0.25
v/c Ratio	1.00	0.32
Control Delay	74.4	10.4
Queue Delay	0.0	0.0
Total Delay	74.4	10.4
LOS	E	B
Approach Delay	70.7	
Approach LOS	E	
Queue Length 50th (ft)	366	14
Queue Length 95th (ft)	#509	70
Internal Link Dist (ft)	211	
Turn Bay Length (ft)		175
Base Capacity (vph)	899	503
Starvation Cap Reductn	0	0
Spillback Cap Reductn	0	0
Storage Cap Reductn	0	0
Reduced v/c Ratio	1.00	0.32
<b>Intersection Summary</b>		

Lanes, Volumes, Timings  
 3: Lemon Street & Orangethorpe Avenue

05/28/2021

Intersection Capacity Utilization 101.0% ICU Level of Service G

Analysis Period (min) 15

~ Volume exceeds capacity, queue is theoretically infinite.

Queue shown is maximum after two cycles.

# 95th percentile volume exceeds capacity, queue may be longer.





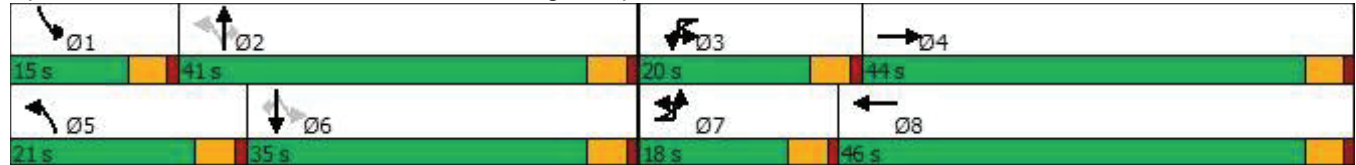













Queue shown is maximum after two cycles.

Splits and Phases: 3: Lemon Street & Orangethorpe Avenue



Lanes, Volumes, Timings  
 4: Lemon Street & South Project Access

05/28/2021

												
Lane Group	EBL	EBT	EBR	WBL	WBT	WBR	NBL	NBT	NBR	SBL	SBT	SBR
Lane Configurations								 			 	
Traffic Volume (vph)	0	0	77	0	0	54	0	1379	42	0	1058	24
Future Volume (vph)	0	0	77	0	0	54	0	1379	42	0	1058	24
Ideal Flow (vphpl)	1900	1900	1900	1900	1900	1900	1800	1900	1900	1800	1900	1900
Storage Length (ft)	0		0	0		0	20		0	50		0
Storage Lanes	0		1	0		1	0		0	0		1
Taper Length (ft)	25			25			25			25		
Satd. Flow (prot)	0	0	1611	0	0	1611	0	3525	0	0	3539	1583
Flt Permitted												
Satd. Flow (perm)	0	0	1611	0	0	1611	0	3525	0	0	3539	1583
Link Speed (mph)		25			30			40			40	
Link Distance (ft)		267			71			291			254	
Travel Time (s)		7.3			1.6			5.0			4.3	
Peak Hour Factor	0.92	0.92	0.92	0.92	0.92	0.92	0.92	0.92	0.92	0.92	0.92	0.92
Shared Lane Traffic (%)												
Lane Group Flow (vph)	0	0	84	0	0	59	0	1545	0	0	1150	26
Sign Control		Stop			Stop			Free			Free	
<b>Intersection Summary</b>												
Area Type:	Other											
Control Type:	Unsignalized											
Intersection Capacity Utilization	49.5%						ICU Level of Service A					
Analysis Period (min)	15											

HCM 6th TWSC  
4: Lemon Street & South Project Access

05/28/2021

Intersection

Int Delay, s/veh 0.8

Movement	EBL	EBT	EBR	WBL	WBT	WBR	NBL	NBT	NBR	SBL	SBT	SBR
Lane Configurations			↑			↑		↑↑			↑↑	↑
Traffic Vol, veh/h	0	0	77	0	0	54	0	1379	42	0	1058	24
Future Vol, veh/h	0	0	77	0	0	54	0	1379	42	0	1058	24
Conflicting Peds, #/hr	0	0	0	0	0	0	0	0	0	0	0	0
Sign Control	Stop	Stop	Stop	Stop	Stop	Stop	Free	Free	Free	Free	Free	Free
RT Channelized	-	-	None	-	-	None	-	-	None	-	-	None
Storage Length	-	-	0	-	-	0	-	-	-	-	-	0
Veh in Median Storage,-#	0	-	-	0	-	-	0	-	-	0	-	-
Grade, %	-	0	-	-	0	-	-	0	-	-	0	-
Peak Hour Factor	92	92	92	92	92	92	92	92	92	92	92	92
Heavy Vehicles, %	2	2	2	2	2	2	2	2	2	2	2	2
Mvmt Flow	0	0	84	0	0	59	0	1499	46	0	1150	26

Major/Minor	Minor2	Minor1	Major1	Major2								
Conflicting Flow All	-	-	575	-	-	773	-	0	0	-	-	0
Stage 1	-	-	-	-	-	-	-	-	-	-	-	-
Stage 2	-	-	-	-	-	-	-	-	-	-	-	-
Critical Hdwy	-	-	6.94	-	-	6.94	-	-	-	-	-	-
Critical Hdwy Stg 1	-	-	-	-	-	-	-	-	-	-	-	-
Critical Hdwy Stg 2	-	-	-	-	-	-	-	-	-	-	-	-
Follow-up Hdwy	-	-	3.32	-	-	3.32	-	-	-	-	-	-
Pot Cap-1 Maneuver	0	0	461	0	0	342	0	-	-	0	-	-
Stage 1	0	0	-	0	0	-	0	-	-	0	-	-
Stage 2	0	0	-	0	0	-	0	-	-	0	-	-
Platoon blocked, %								-	-	-	-	-
Mov Cap-1 Maneuver	-	-	461	-	-	342	-	-	-	-	-	-
Mov Cap-2 Maneuver	-	-	-	-	-	-	-	-	-	-	-	-
Stage 1	-	-	-	-	-	-	-	-	-	-	-	-
Stage 2	-	-	-	-	-	-	-	-	-	-	-	-

Approach	EB	WB	NB	SB
HCM Control Delay, s	14.5	17.7	0	0
HCM LOS	B	C		

Minor Lane/Major Mvmt	NBT	NBR	EBLn	WBLn1	SBT	SBR
Capacity (veh/h)	-	-	461	342	-	-
HCM Lane V/C Ratio	-	-	0.182	0.172	-	-
HCM Control Delay (s)	-	-	14.5	17.7	-	-
HCM Lane LOS	-	-	B	C	-	-
HCM 95th %tile Q(veh)	-	-	0.7	0.6	-	-

Lanes, Volumes, Timings  
 5: Lemon Street & North Project Access/Liberty Avenue

08/17/2021



Lane Group	EBL	EBT	EBR	WBL	WBT	WBR	NBL	NBT	NBR	SBL	SBT	SBR
Lane Configurations		↕	↗		↕		↗	↕↗		↗	↕↕	↗
Traffic Volume (vph)	75	0	96	36	1	23	178	1212	11	1	933	76
Future Volume (vph)	75	0	96	36	1	23	178	1212	11	1	933	76
Ideal Flow (vphpl)	1900	1900	1900	1900	1900	1900	1800	1900	1900	1800	1900	1900
Storage Length (ft)	0		0	0		0	50		0	50		75
Storage Lanes	0		1	0		0	1		0	1		1
Taper Length (ft)	25			25			25			25		
Satd. Flow (prot)	0	1770	1583	0	1715	0	1676	3536	0	1676	3539	1583
Flt Permitted		0.950			0.971		0.172			0.148		
Satd. Flow (perm)	0	1770	1583	0	1715	0	304	3536	0	261	3539	1583
Right Turn on Red			Yes			Yes			Yes			Yes
Satd. Flow (RTOR)			127		25			1				127
Link Speed (mph)		30			25			40			40	
Link Distance (ft)		333			454			254			394	
Travel Time (s)		7.6			12.4			4.3			6.7	
Peak Hour Factor	0.92	0.92	0.92	0.92	0.92	0.92	0.92	0.92	0.92	0.92	0.92	0.92
Shared Lane Traffic (%)												
Lane Group Flow (vph)	0	82	104	0	65	0	193	1329	0	1	1014	83
Turn Type	Split	NA	Perm	Split	NA		pm+pt	NA		pm+pt	NA	Perm
Protected Phases	4	4		8	8		5	2		1	6	
Permitted Phases			4				2			6		6
Total Split (s)	20.0	20.0	20.0	16.0	16.0		10.0	44.0		10.0	44.0	44.0
Total Lost Time (s)		4.5	4.5		4.5		4.5	4.5		4.5	4.5	4.5
Act Effct Green (s)		9.0	9.0		7.6		39.8	40.5		35.5	29.5	29.5
Actuated g/C Ratio		0.14	0.14		0.12		0.64	0.65		0.57	0.47	0.47
v/c Ratio		0.32	0.31		0.28		0.59	0.58		0.00	0.61	0.10
Control Delay		32.7	7.2		25.0		19.3	12.6		8.0	16.3	1.3
Queue Delay		0.0	0.0		0.0		0.0	0.0		0.0	0.0	0.0
Total Delay		32.7	7.2		25.0		19.3	12.6		8.0	16.3	1.3
LOS		C	A		C		B	B		A	B	A
Approach Delay		18.5			25.0			13.5			15.2	
Approach LOS		B			C			B			B	
Queue Length 50th (ft)		31	0		15		35	180		0	172	0
Queue Length 95th (ft)		83	31		58		#119	410		2	277	10
Internal Link Dist (ft)		253			374			174			314	
Turn Bay Length (ft)							50			50		75
Base Capacity (vph)		480	522		365		325	2431		284	2413	1119
Starvation Cap Reductn		0	0		0		0	20		0	0	0
Spillback Cap Reductn		0	0		0		0	0		0	0	0
Storage Cap Reductn		0	0		0		0	0		0	0	0
Reduced v/c Ratio		0.17	0.20		0.18		0.59	0.55		0.00	0.42	0.07

**Intersection Summary**

Area Type: Other

Cycle Length: 90

Actuated Cycle Length: 62.4

Control Type: Actuated-Uncoordinated

Maximum v/c Ratio: 0.61

Intersection Signal Delay: 14.7

Intersection LOS: B



Lanes, Volumes, Timings

5: Lemon Street & North Project Access/Liberty Avenue

08/17/2021

Intersection Capacity Utilization 59.4% ICU Level of Service B

Analysis Period (min) 15

# 95th percentile volume exceeds capacity, queue may be longer.

Queue shown is maximum after two cycles.

Splits and Phases: 5: Lemon Street & North Project Access/Liberty Avenue

 Ø1	 Ø2	 Ø4	 Ø8
10 s	44 s	20 s	16 s
 Ø5	 Ø6		
10 s	44 s		

## Appendix F – VMT Assessment

## TRANSPORTATION ASSESSMENT POLICIES AND PROCEDURES (TAPP) WORKSHEET

<b>PROJECT NUMBER</b>	PRJ2020-00004
<b>PROJECT NAME</b>	Street Lights Fullerton
<b>PROJECT LOCATION</b>	229 E. Orangethorpe Avenue
<b>APN(s)</b>	073-060-28 / 073-060-64 / 073-060-65
<b>PROJECT PLANNER</b>	Heather Allen
<b>PROPOSED LAND USES</b>	329 Residential Units & 6,500 sqft of Retail
<b>EXISTING LAND USES TO BE REMOVED</b>	15,700 sqft of Shopping Center
<b>VMT SCREENING</b>  <input checked="" type="checkbox"/> Project is exempt from CEQA; therefore, a VMT Analysis is not required.  <input type="checkbox"/> Project passes Primary and Secondary Screening; therefore, a VMT Analysis is not required.  <input type="checkbox"/> Project fails screening; therefore, a VMT Analysis is required.	<u>Primary Screening</u> The Proposed Project: <input checked="" type="checkbox"/> Located in a Transit Priority Area <input type="checkbox"/> Located in a Low VMT-generating area <input type="checkbox"/> Project type is presumed to have a less than significant impact <input checked="" type="checkbox"/> Project generates less than 836 VMT  <i>If any of the above boxes are checked, the project passes Primary Screening and the Project Planner completes applicable Secondary Screening.</i>
	<u>Secondary Screening – Transit Priority Area</u> The Proposed Project: <input type="checkbox"/> Has a Floor Area Ratio (FAR) of less than 0.75 <input type="checkbox"/> Is overparked in relation to City Code. <input type="checkbox"/> Is inconsistent with the applicable Sustainable Communities Strategy <input type="checkbox"/> Replaces affordable residential units with a smaller number of moderate- or high-income residential units.  <i>If any of the above boxes are checked, the project fails Secondary Screening.</i>
	<u>Secondary Screening – Low VMT-generating Area</u> The Proposed Project: <input type="checkbox"/> Is inconsistent with the existing land use <sup>1</sup> (i.e. if the project is proposing single-family housing, there should be existing single-family housing of approximately the same density); or  <input type="checkbox"/> Has a unique attribute that would otherwise be misrepresented utilizing the data from the travel demand model such as including land uses that would alter the existing built environment in such a way as to increase the rate or length of vehicle trips.  <i>If any of the above boxes are checked, the project fails Secondary Screening.</i>

<sup>1</sup> Residential and office projects located within a low VMT area may be presumed to have a less than significant impact absent substantial evidence to the contrary. In addition, other employment- related and mixed- use land use projects may qualify for the use of screening if the project can reasonably be expected to generate VMT per service population that is similar to the existing land uses in the low VMT area.

<p><b>VMT ANALYSIS</b></p> <p><input checked="" type="checkbox"/> Preliminary project analysis reveals no probable VMT impact, therefore, no further study is required.</p> <p><input type="checkbox"/> Project may have a VMT impact and thus a VMT Analysis is required.</p>	<p>The Proposed Project:  Estimated Daily Trips: 3,227  Average Trip Length: 6.4  Service Population 842  VMT per Service Population: 24.5  VMT Credit: 22,074</p> <p>Target VMT per Service Population Threshold: 29.6  Percentage above/below VMT Target: -17.23%</p> <p>City Traffic Engineer's Finding:  <i>The proposed project replaces several buildings in the Fullerton Town Center shopping center with a multi-story mixed-use residential project and parking garage. The implementation of the proposed project is likely to result in 222 fewer daily trips to/from the site and thus it can be assumed that the net VMT for the project is negative. The proposed project is also located within a TPA and qualifies for VMT screening. Analysis of the proposed project without a VMT credit resulted in a 17% lower VMT generation rate than General Plan Buildout. Therefore, based on this review it is reasonable to conclude that the proposed project will have no probable VMT impact.</i></p>
<p><b>LOS SCREENING</b></p> <p><input type="checkbox"/> Project is not expected to have an effect on transportation; therefore, a LOS Analysis is not required.</p> <p><input checked="" type="checkbox"/> Project fails screening and may have a potential effect on transportation; therefore, a LOS Analysis is required.</p>	<p>The Proposed Project:  Peak Hour Trip Generation: AM: 125  PM: 170</p> <p>Peak Hour Trip Credit: AM: 22  PM: 122</p> <p>Proposed Project Net Peak Trip Generation: AM: 103  PM: 48</p> <p><input checked="" type="checkbox"/> AM or PM peak hour trip generation is anticipated to exceed 40 net new vehicle trips.  <input type="checkbox"/> The combination of land use and location necessitates further study.</p> <p><i>If any of the above boxes are checked, the project fails LOS Screening.</i></p>
<p><b>Approved by:</b></p>	 David Roseman City Traffic Engineer August 8, 2021

# NOCC+



## North Orange County Collaborative VMT Traffic Study Screening Tool

### Project Information

Project Name	Opening Year
229 E Orangethorpe - Street Lights	2023
Parcel Number ( OCTAM TAZ#126 )	
073-060-28, 073-060-64, 073-060-65	

### Screening Criteria for Fullerton

Is the project location in a Transit Priority Area?	Yes
Is the project location in a low VMT generating zone?	No
Is the Project one of these land use types? (show land use types)	No
Does the project generate fewer than 836 VMT? (enter project land use in the section below)	No
	<b>Yes by Net VMT</b>

The Project can be considered for screening from additional analysis.  
Please refer to the 'secondary screening checks' table in the User Guide.

### Project Land Use Information

		Unit
Residential : Single Family Homes	0	Dwelling Units
Residential : MultiFamily Homes	329	Dwelling Units
Office	0.000	1,000 Sqaure Feet
Retail	6.500	1,000 Sqaure Feet
Industrial	0.000	1,000 Sqaure Feet
Private School	0	Students
University	0	Students
Entertainment	0.000	1,000 Sqaure Feet
Hotel	0	Rooms

### Project Trips and VMT Information

VMT Methodology

Daily Trips: 3227 Average Trip Length: 6.4 Service Population: 842

VMT per service population 24.5

### Project VMT Thresholds Comparison

- OPR Guidance (15% Below Existing)
- GHG Reduction Targets (14.3% Below Existing)
- Below Existing
- Better than General Plan Buildout

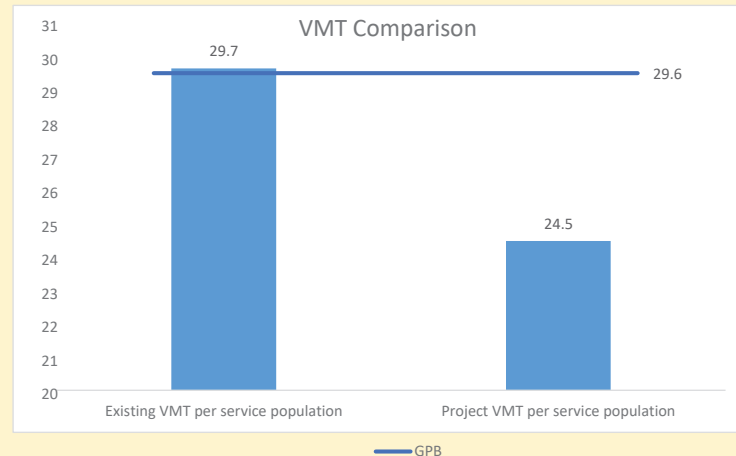



Balancing the Natural and Built Environment

[www.Psomas.com](http://www.Psomas.com)